

INSTRUCCIONES

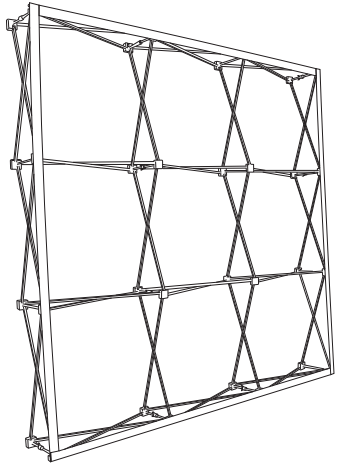

 CONTENIDO



x1

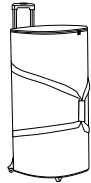

x1

Abra la bolsa, verifique el contenido de la bolsa y saque todas las piezas con cuidado.

Para montar el Pop Up, en primer lugar se recomienda desplegar su estructura en el suelo y no ponerse de pie hasta haber colocado el gráfico, como se muestra en los siguientes 2 pasos a continuación.

1

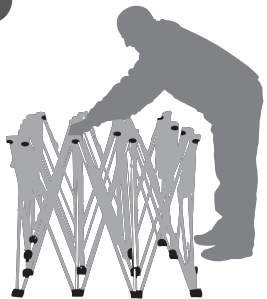

2

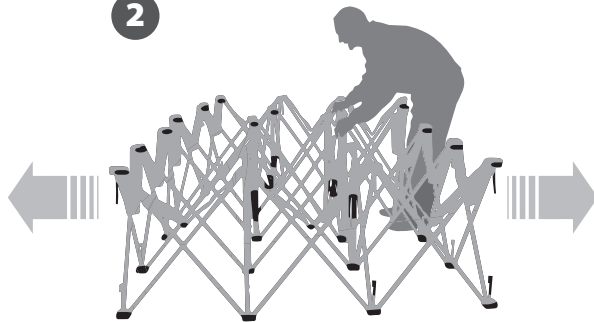

INSTRUCCIONES

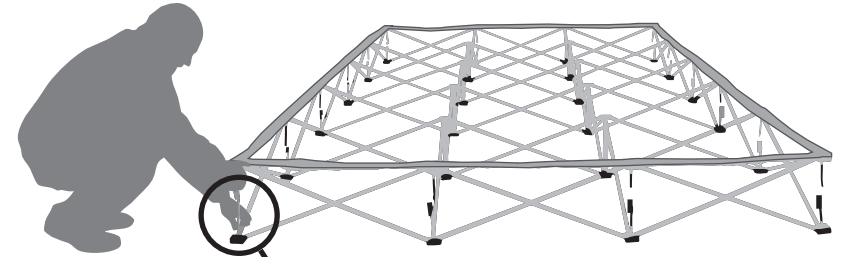

3

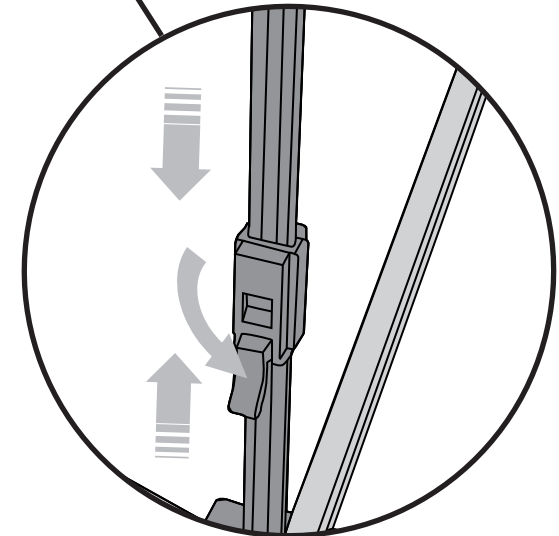

ISTRUCCIONES

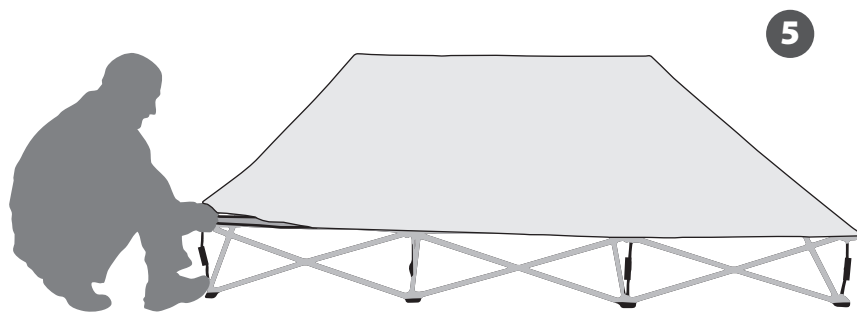
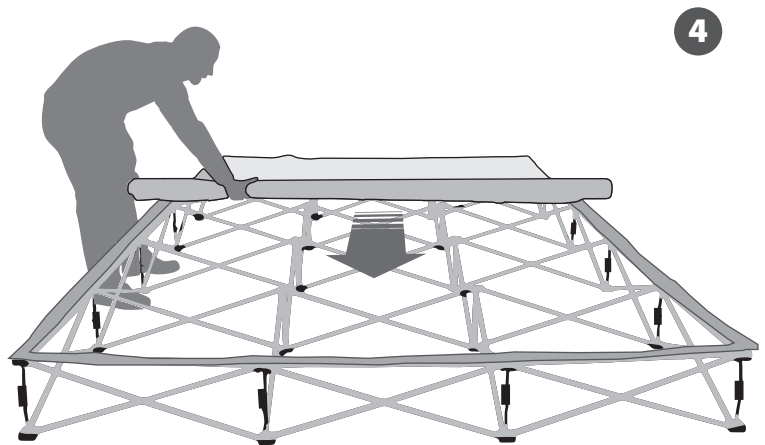

ISTRUCCIONES

