

8
1
2

soportes
publicitarios

**DISPENSADORES
de productos en promoción**

DISPENSADORES |



EN Dispensers made of different materials for the exhibition and sale of promotional items.

FR Présentoir fabriqué en différents types de matériaux pour vente et l'exposition de produits.

PT Expositor fabricado em diferentes materiais, para a venda e exibição de produtos.

ES Expositores realizados en diferentes materiales para la exposición y venta de artículos.



dispensador frontal

TABLE DISPLAY

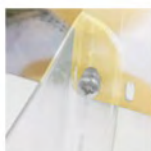
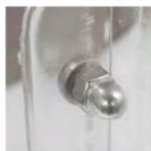

INFORMATION

*mm

This multipurpose table merchandiser features 1 front dispenser and is very easy and fast to assemble. It allows you to customize the presentation with your own graphics. Perfect as eye-catching point of purchase presentation on any counter to display the last minute add-on items, for customers to purchase as they are checking out.

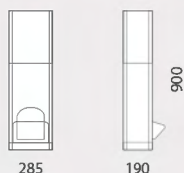

TABLE DISPLAY	QTY	N.W	G.W	C.B.M	SIZE
Packing	1	2.5kg	3.6kg	0.058	300x210x920mm
10.475	Total Display Size: 285x190x900mm				

WALL DISPLAY



INFORMATION

*mm

This stand merchandiser features 1 front dispenser and is easy to set-up. It allows to customize it with your own graphics. Perfect as eye-catching point of purchase presentation at any mall or shop.

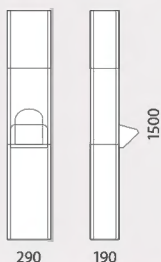

WALL DISPLAY	QTY	N.W	G.W	C.B.M	SIZE
Packing	1	3.7kg	5.46kg	0.1238	335x240x1540mm
10.476	Total Display Size: 290x190x1500mm				

FLOOR DISPLAY



INFORMATION

*mm

This stand merchandiser features 2 front dispensers and is easy to set-up. It allows to customize it with your own graphics. Perfect as eye-catching point of purchase presentation at any mall or shop.

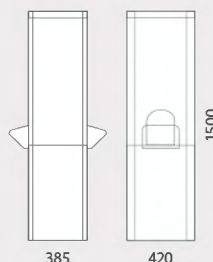

FLOOR DISPLAY	QTY	N.W	G.W	C.B.M	SIZE
Packing	1	7.35kg	8.2kg	0.27	450x400x1520mm
10.477	Total Display Size: 420x385x1500mm				



INFORMATION

*mm

This squared dumpbin is made of transparent plastic. Features 1 shelf and the possibility of placing it in two different heights, so in this way you can have two different capacities for displaying the product. Also, you can add your customized print to one or more faces of the bin to suit your own requirements. The edge of the upper perimeter is reinforced with protective cover. Promo Square is lightweight, ideal as floor standing unit for being used in your store. Place the piece near to the point of purchase locations for impulse buys on any merchandise you choose.



PROMO SQUARE

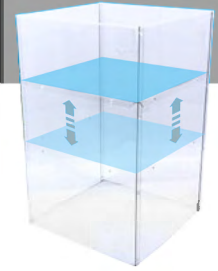

2 heights available
370mm or 610mm

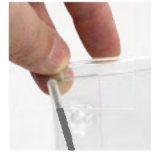

plástico transparente



P.SQUARE	QTY	N.W	G.W	C.B.M	SIZE
Packing	1	4.35kg	5.1kg	0.02	540x45x900mm
10.440	Graphic Size: 610x505mm(x4) or 370x505(x4)				

INFORMATION

*mm

This Easy Dispenser Display is made of injected plastic. Features 3 shelves and top surface of a lower module with wheels. So in this way you have 4 spaces for displaying and exhibition of the product. Also, you can add your customised print to the top header and faces of the cardboard lower module (included) to suit your own requirements. This mobile display is very easy to move inside your business, ideal as floor standing unit to use it wherever the local need is required. Place the piece near the point of purchase locations for impulse buys on any merchandise you choose.

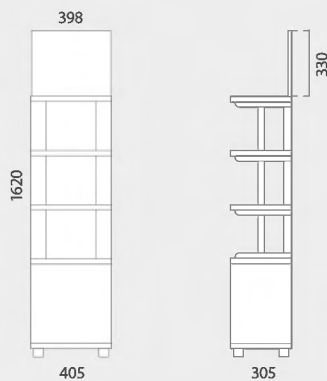

"EASY"

4 estantes



"EASY"	QTY	N.W	G.W	C.B.M	SIZE
Packing	1	4kg	4.8kg	0.0572	520x155x710mm
10.478	Total Dispenser Size: 305x405x1620mm				

DISPENSADORES |



EN Display made of injected plastic, for the exhibition and implementation of products. Easy to assemble. The plastic screws and assembling pieces for the billboard can be interchangeable between the display units, depending model.

FR Présentoir en plastique injecté pour l'exposition et l'implantation de produits. Montage simple et rapide. Les vis en plastique et les pièces du support des visuels (interchangeable) sont fournies selon le modèle.

PT Expositor em plástico injectado para promoção e implantação de artigos. Montagem fácil. Inclui os parafusos e as peças de fixação necessárias para a colocação da impressão nos módulos, dependendo do modelo.

ES Expositor realizado en plástico injectado para la exposición e implantación de productos. Montaje sencillo. Los tornillos de plástico y la sujeción de cartelería se suministran con los displays, según modelo.

PROMO SHOP

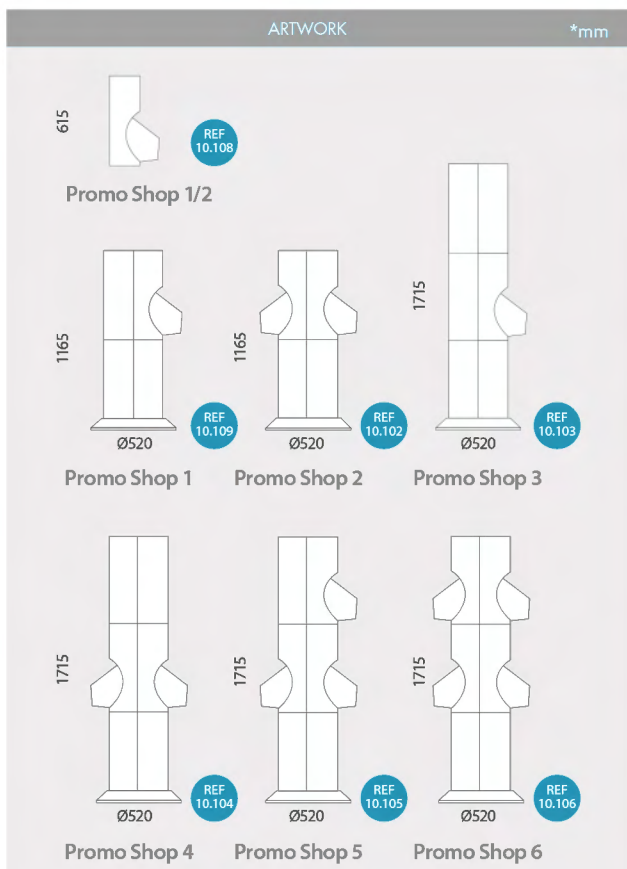

INFORMATION

This merchandiser stand is made of injected plastic and features an easy configuration to set-up. It allows personalization with graphs and a personal configuration, choosing the number of dispensers that require your needs. Perfect as eye-catching point of purchase presentation at any mall or shop.

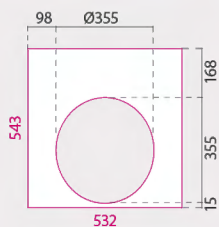

TOTAL GRAPHIC

STANDARD SIZES

PROMO SHOP	GRAPHIC SIZE
10.108	Promo Shop 1/2
10.109	Promo Shop 1
10.102	Promo Shop 2
10.103	Promo Shop 3
10.104	Promo Shop 4
10.105	Promo Shop 5
10.106	Promo Shop 6



1 - 4 dispensadores





PROMO SHOP



EN

SETUP:

- 1. Place the pieces that will hold the graphic as picture ③.
- 2. Join the pieces of part ① and ② of the exhibitor.
- 3. If you want to place the vertical divider, join parts ① and ②, then the exhibitor is being divided into two parts.
- 4. Place the base (disk piece) on the bottom of the exhibitor.
- 5. Next, place the screws through the holes.
- 6. Place the graphic on its correspondent place.
- 7. Assemble the different modules.
- 8. Tighten the screws with the nuts.

FR

MONTAGE:

- 1. Placer les pièces de fixation du visuel sur l'image ③.
- 2. Unir les parties ① et ② du présentoir.
- 3. Si vous désirez un séparateur vertical, placé-le lorsque vous unirez les parties ① et ②, vous obtiendrez ainsi un présentoir divisé en deux parties.
- 4. Emboîter le disque séparateur au fond du présentoir.
- 5. Mettre les vis dans chaque trou.
- 6. Placer le visuel.
- 7. Monter les différents modules.
- 8. Serrer les vis avec les écrous.

PT

MONTAGEM:

- 1. Colocar as peças de fixação na impressão de acordo com a imagem ③.
- 2. Unir as partes ① e ② do expositor.
- 3. Se desejar o separador vertical, terá de colocá-lo ao unir as partes ① e ②, ficando o expositor dividido ao meio.
- 4. Encaixar o disco separador no fundo do expositor.
- 5. Introduzir os parafusos de forma a que atravessassem todos os orifícios.
- 6. Colocar as impressões.
- 7. Montar os diferentes módulos.
- 8. Apertar os parafusos com as respectivas porcas.

ES

MONTAJE:

- 1. Colocar las piezas de sujección de cartelería, ver fotografía ③.
- 2. Unir las partes ① y ② del expositor.
- 3. Si desea separador vertical colocar al unir las partes ① y ②, quedando entonces el expositor dividido en dos partes.
- 4. Encajar el disco separador como base en el fondo del expositor.
- 5. A continuación, colocar los tornillos, atravesando todos los agujeros.
- 6. Colocar las gráficas.
- 7. Montar los distintos módulos.
- 8. Apretar los tornillos con las tuercas.

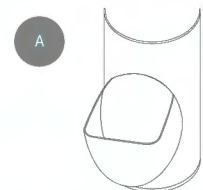
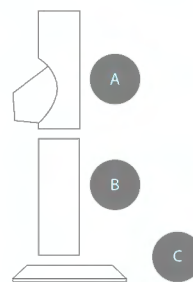
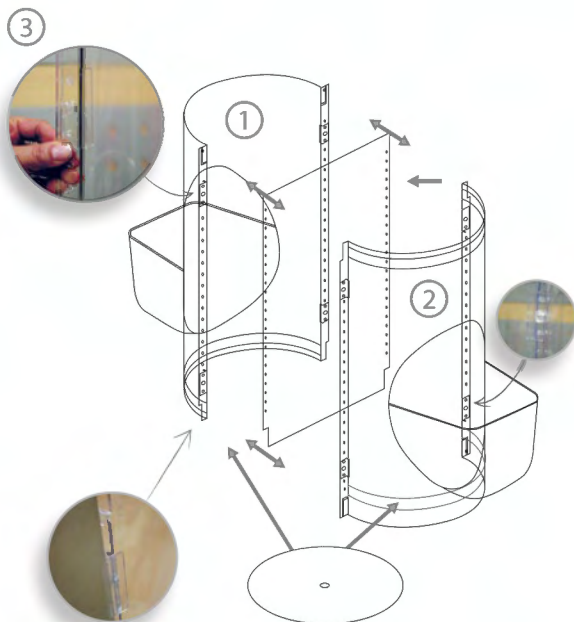

DISPENSER SECTION	QTY	N.W
Packing	1	1.1kg

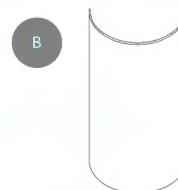

FLAT SECTION	QTY	N.W
Packing	1	1kg

BASE SECTION	QTY	N.W
Packing	1	0.5kg



WOODEN
PROMO BOWL

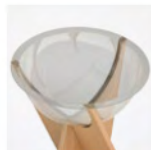

base
de
madera



INFORMATION

*mm

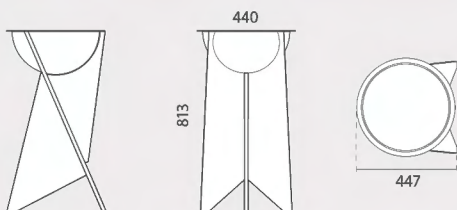

This merchandising bowl with wooden base is ideal for displaying the last minute add-on items thanks its 440mm diameter semisphere made of transparent polycarbonate. Perfect for exhibition at playstores, malls or shops.

W.P.BOWL	QTY	N.W	G.W	C.B.M	SIZE
Semisphere	1	0.75kg	1.85kg	0.0561	492x485x235mm
Wood Base	1	4.95kg	5.75kg	0.0196	900x435x50mm
13.481		Natural Wood			

ALUMINIUM
PROMO BOWL



semi esfera
con gran
visibilidad para
el producto



8 kg base

INFORMATION

*mm

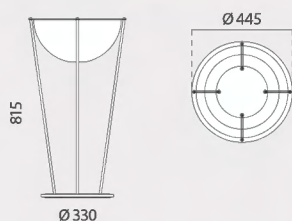

This merchandising bowl with wooden base is ideal for displaying the last minute add-on items thanks its 440mm diameter semisphere made of transparent polycarbonate. Perfect for exhibition at playstores, malls or shops.

A.P.BOWL	QTY	N.W	G.W	C.B.M	SIZE
Semisphere	1	1.15kg	2.35kg	0.0561	492x485x235mm
Base	1	5kg	5.3kg	0.0055	350x350x45mm
50.383		Semisphere: Ø445mm Base: Ø330mm			



PROMO BOWL



INFORMATION

*mm

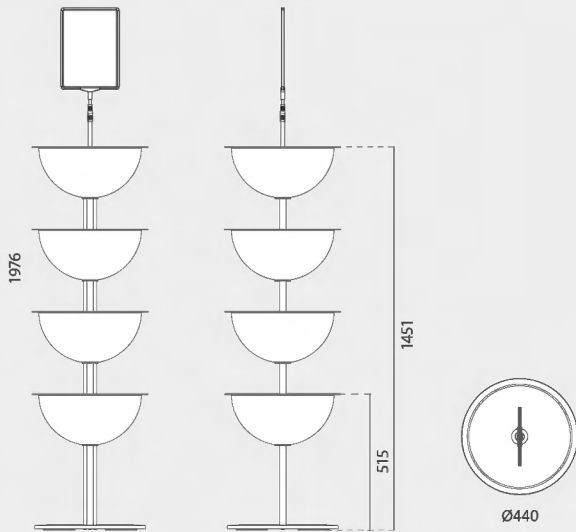

This merchandising multi-bowl is ideal for displaying the last minute add-on items thanks its 440mm diameter semispheres made of transparent polycarbonate. Adding 4 Bowls semispheres for the exhibition of more varieties of product. Perfect for exhibition of candies, cosmetics, hair accessories, and much more. Bowl displays are becoming a very popular way to showcase merchandise at playstores, malls or shops.

P.BOWL	QTY	N.W	G.W	C.B.M	SIZE
Semisphere	1	2.95kg	3.95kg	0.0714	454x455x345mm
Base+Profile	1	9kg	10kg	0.0714	455x455x345mm
10.802	Semisphere: Ø440mm				



marco incluido

Ø 440mm
semi esferas
de
policarbonato



8 kg base



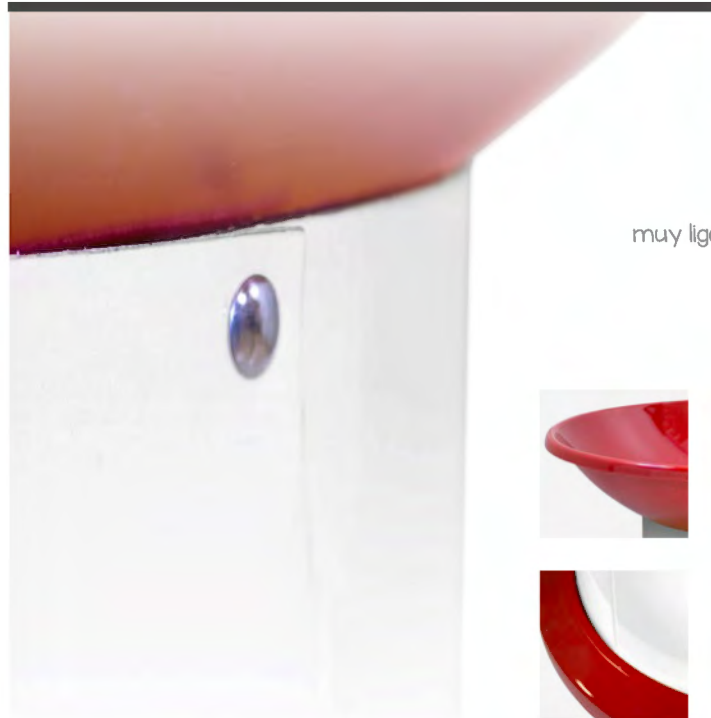

PROMO CASH

muy ligero

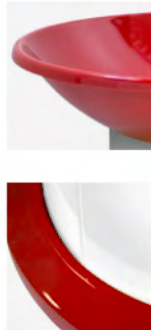

675mm
diámetro

INFORMATION *mm

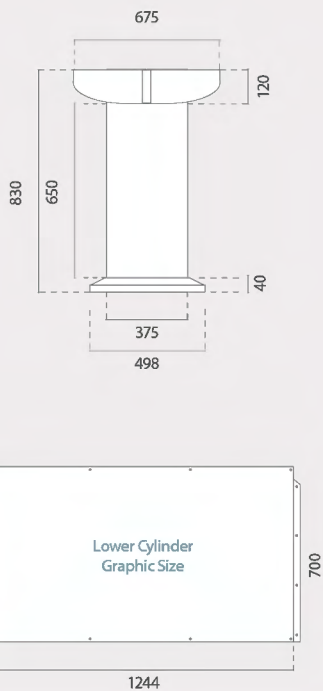

This merchandising bowl features a 675mm diameter semisphere made of plastic. It allows personalization with graphic. The Promo Bowls are ideal for the exhibition of toys, candies, cosmetics or last minute add-on items. Bowl displays are becoming a very popular way to showcase merchandise, samples or gifts at playstores, malls, shops, etc.



13.468 Graphic Size: 1244x700mm



PROMO BRAND

fácil acceso al producto



INFORMATION

*mm

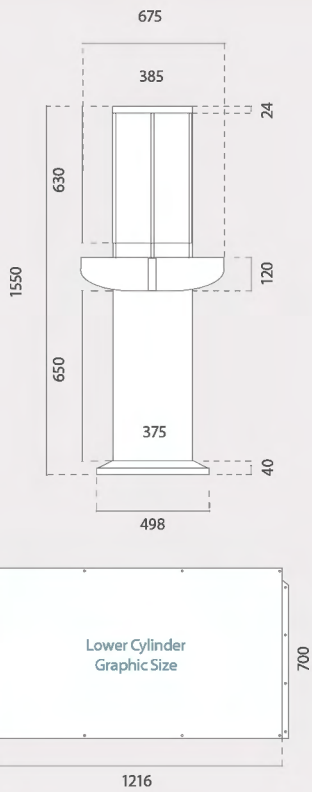

Lower Cylinder
Graphic Size

This fully removable merchandising bowl features a 675mm diameter hemisphere made of plastic and transparent cylinder for the exhibition of items. Base allows the customization with graphic. The Promo Bowls are ideal for the exhibition of toys, candies, cosmetics, merchandising, samples, gifts or last minute add-on items at playstores, malls, shops, etc.



10.429

Graphic Size: 1216x700mm



PROMO STORE



INFORMATION

*mm

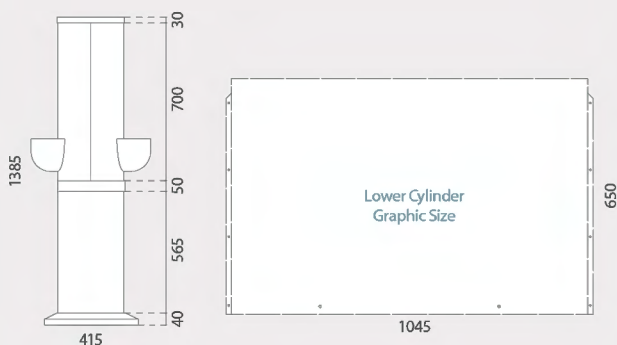

This fully removable merchandising display features 2 dispensers made of plastic and a transparent divided cylinder for the exhibition of 2 classes of products. Also it is available in blue or red color and the base allows the customization with graphic. This Dispenser Display is lightweight and easy to set-up. The Promo Store is ideal for the exhibition of toys, candies, cosmetics, merchandising, samples, gifts or last minute add-on items at playstores, malls, shops, etc...

P.STORE	QTY	N.W	G.W	C.B.M	SIZE
Packing	1	2.58kg	3.93kg	0.1762	450x440x880mm
10.110		Graphic Size: 1045x650mm			



SHELF DISPLAY



INFORMATION

*mm

This fully removable, lightweight shelving plastic display features 4 colors available. With exposed sides, this 4-sided plastic shelving unit lets customers easily access the items on the display while also providing you a means to quickly restock. Easy to set up, this shelving display will look great in markets or shops.

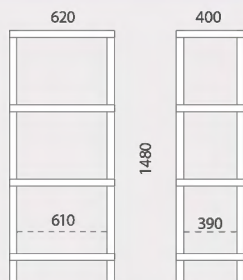

4 colores de estantes disponibles



SHELF D.	QTY	N.W	G.W	C.B.M	SIZE
Packing	1	8kg	8.45kg	0.073	400x290x630mm
10.384	<input type="checkbox"/>	620x400x1480mm			
10.386	<input type="checkbox"/>				
10.387	<input type="checkbox"/>				
10.388	<input type="checkbox"/>				

WIRE DUMPBIN

made of steel

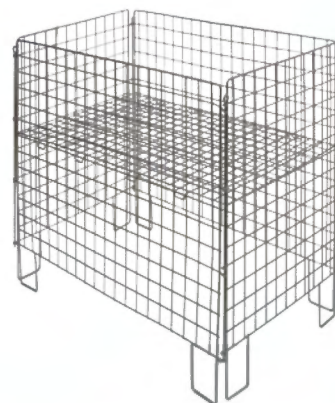
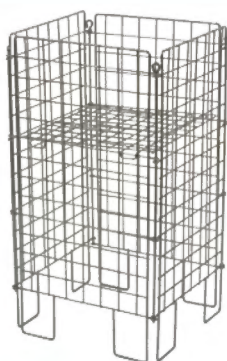

INFORMATION

*mm

Wire dumpbin features a collapsible design which allows an easy setup, packing and for storing. Frame spacing allows for lifts to be used during store resets. Small model.

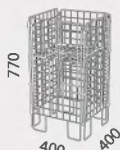

INFORMATION

*mm

Wire dumpbin features a collapsible design which allows an easy setup, packing and storing. Frame spacing allows for lifts to be used during store resets. Medium model.

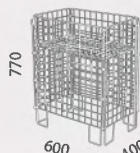

INFORMATION

*mm

Wire dumpbin features a collapsible design which allows an easy setup, packing and for storing. Frame spacing allows for lifts to be used during store resets. Big model.

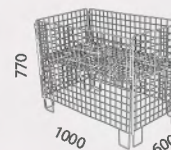

WIRE D.1	QTY	N.W	G.W	C.B.M	SIZE
Packing	1	7.2kg	8.4kg	0.2	795x425x550mm
50.350	400x400x770mm				

WIRE D.2	QTY	N.W	G.W	C.B.M	SIZE
Packing	1	8.8kg	10.2kg	0.27	795x620x550mm
50.351	600x400x770mm				

WIRE D.3	QTY	N.W	G.W	C.B.M	SIZE
Packing	1	13.6kg	15.2kg	0.52	1205x790x550mm
50.352	1000x600x770mm				



TINEO MULTIFUNCTION SHELF

do your own
configuration:

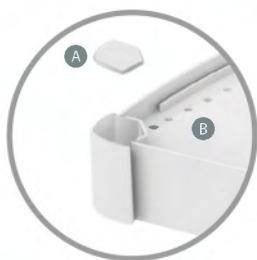

1

Get your pack of 4 top covers **A** and 4 shelves **B** (white, red or blue color)

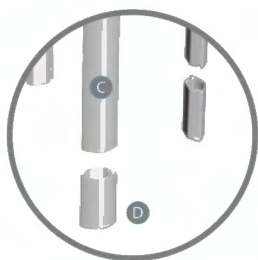

2

Combine with the pack of 12 poles **C** and 4 bottom feet **D** (white, red, blue or black)



INFORMATION

*mm

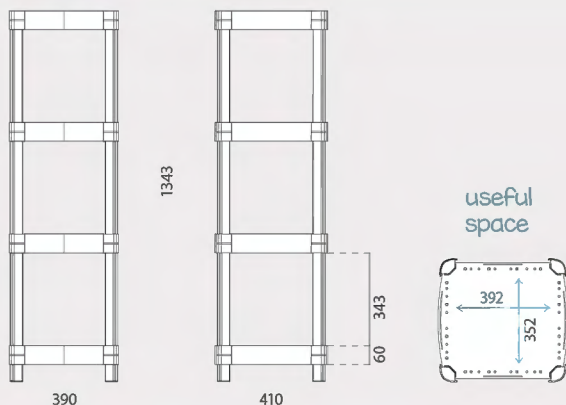

With exposed sides, this 4-sided plastic shelving unit lets customers easily access the items on display while also providing you a means to quickly restock. To make things even easier, the multi-function Tineo shelving is designed to support new configurations applied by the customer, such as turning it into a display cabinet by using panels or incorporating graphics to the sides. Easy to assemble, each piece is designed for quick installation and use. Features 3 colors for your own customization: white, red or blue. Combine your pack of 4 shelves and 4 covers with the pack of 12 poles + 4 bottom feet. If you want to turn this shelf display to mobile, wheels for Tineo are also available. Tineo has multiple functions for selling, displaying or promoting products, so is a practical display case that will look great in markets, shops, exhibition events, stores or even at home.

PACK 4 SHELVES + 4 TOP COVERS

TINEO 4S+4C	QTY	N.W	G.W	C.B.M	SIZE
Packing	1	4.1kg	4.6kg	0.0437	420x400x260mm
Shelf / Cover	<input type="checkbox"/>	<input checked="" type="checkbox"/>	<input checked="" type="checkbox"/>	<input type="checkbox"/>	
13.719	Pack: 4 shelves + 4 top covers				



PACK 12 POLES + 4 BOTTOM FEET

TINEO 12P+4F	QTY	N.W	G.W	C.B.M	SIZE
Packing	1	1.70kg	2.05kg	0.0110	415x355x75mm
Pole / Feet	<input type="checkbox"/>	<input checked="" type="checkbox"/>	<input checked="" type="checkbox"/>	<input checked="" type="checkbox"/>	<input type="checkbox"/>
13.720	Pack: 12 poles + 4 bottom feet				



DISPENSADORES |

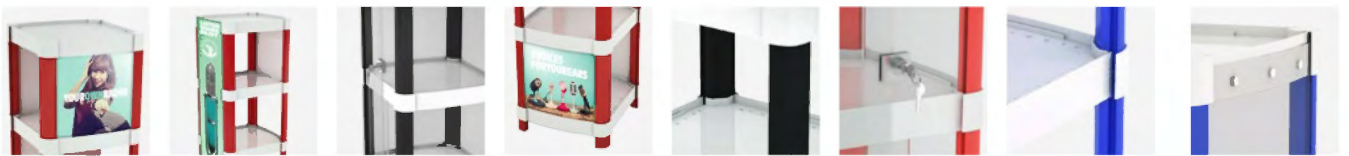

CUSTOMIZATION POSSIBILITIES (APPLIED BY THE CUSTOMER)

- EN Possibilities (applied by the customer) of turning into a cabinet display by panels or adding one or more graphics on any side.
- FR Peut (par le client) se transformer en vitrine avec l'utilisation des panneaux ou d'ajouter une ou plus visuels sur les côtés.
- PT É possível por parte do cliente converter em vitrina o artigo usando painéis ou incorporando uma ou mais impressões nos laterais.
- ES Posibilidad por parte del cliente de convertir en vitrina mediante el uso de paneles o de incorporar una o más gráficas en los laterales.



fully removable!

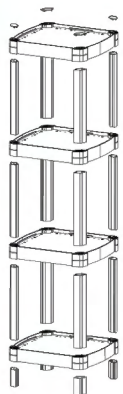

easy and fast set up!

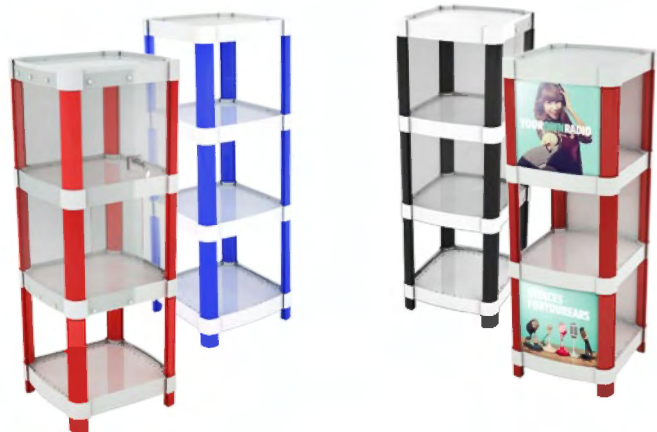
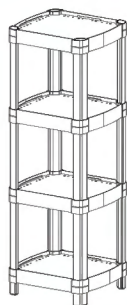

* Customization possibilities are orientative ideas, in no case are supplied with the display / * Les possible personnalisation sont à titre indicative mais ne sont pas incluses dans le display.
 * As possibilidades de personalização são orientativas, em nenhum caso são fornecidas com o artigo./ * Las posibilidades de personalización son orientativas, en ningún caso se suministran con el display.

WHEELS FOR TINEO



easily turn your shelf display from static to mobile

also with leveling feet option available



WHEELS-T.	QTY	N.W	G.W	C.B.M	SIZE
Packing	4	0.3kg	0.35kg	0.0008	130x105x60mm
14.102	2 Wheels + 2 Brake Wheels		x4		

	EN	FR	PT	ES										
	Carry bag included	Avec sac de transport	Inclui bolsa de transporte	Incluye bolsa de transporte		With Adhesive	Avec adhésif	Con adesivo	Con adhesivo		Portrait / Landscape	Vertical ou horizontal	Vertical ou horizontal	Vertical u Horizontal
	One sided	Une face	Uma face	Una cara		Cardboard	Carton	Cartão	Cartón		"Click" System	Système "Click"	Sistema "Click"	Sistema "Click"
	Double-Sided	Double face	Dupla face	Doble cara		With suction pad	Avec ventouse	Com ventosa	Con ventosa		With Velcro	Avec velcro	Com Velcro	Con velcro
	With motion	Avec mouvement	Con movimento	Con movimiento		New Item	Nouvel article	Novidade	Producto nuevo		Acrylic	Acrylique	Acrílico	Acrílico
	With light	Eclairé	Com luz	Con luz		Lightweight	Poids léger	Leve	Ligero		Economic	Économique	Económico	Económico
	LED Technology	Technologie LED	Tecnologia LED	Tecnologia LED		Extraweight	Poids supplémentaire	Peso extra	Peso extra		Tools required	Outils nécessaire	Montagem com ferramentas	Requiere herramientas
	Telescopic	Télescopique	Telescópico	Telescópico		Flexible	Flexible	Flexível	Basculante		No tools required	Aucun outil requis	Montagem sem ferramentas	No requiere herramientas
	Printed on fabric	Impression sur toile	Impressão têxtil	Impresión sobre textil		Magnetic	Aimanté	Magnético	Magnético	QTY	Quantity	Quantité	Quantidade	Cantidad
	With lock	Avec serrure	Com fechadura	Con cerradura		Plug-in	A Brancher	Elétrico	A corriente	NW	Net weight	Poids net	Peso líquido	Peso neto
	Rainproof	Imperméable	Impermeável	Impermeable		Big Sizes	Grandes tailles	De grandes dimensões	Grandes dimensiones	GW	Gross weight	Poids brut	Peso bruto	Peso bruto
	Suitable for outdoor use	Pour l'extérieur	Para exterior	Para exterior		Portrait	Verticale	Vertical	Vertical	CBM	Cubic meter	Metres cubes	Metro cúbico	Metro cúbico
	With spotlights	Avec spot	Com focos	Focos incluidos		Landscape	Horizontale	Horizontal	Horizontal	Size	Measures	Mesures	Medidas	Medidas



CONTACTE CON NOSOTROS ¡AHORA!

Escribanos, llámenos o venga a visitarnos a nuestras instalaciones. Estaremos encantados de atenderle. Para conocernos un poco más visite nuestra **web corporativa**.

DIRECCIÓN

La Cartelera y el Equipamiento Comercial, SL

Calle Luis I, 45 Nave A
Polígono Industrial de Vallecas
28031 Madrid

info@doncarteltienda.es

Teléfono gratuito de atención a clientes:
900 897 122

Horario de Lunes a Jueves:
De 9 a 14 h y de 16 a 18 h.

Horario Viernes: De 9 a 14 h.



@doncarteltienda



facebook.com/doncarteltienda



google.com/+DoncarteltiendaEstuweb



https://es.linkedin.com/in/doncarteltienda



https://www.flickr.com/photos/doncarteltienda



youtube.com/c/DoncarteltiendaEstuweb



instagram.com/doncarteltienda/



es.pinterest.com/doncarteltienda/doncarteltienda



doncarteltienda.es/blog/feed/

