

2016



doncarteltienda.es

PortaFolletos
de Pie

PortaFolletos - PortaCatálogos

Combi   

EN Full set of holders of easy assembly. The displays "Combi" are supplied in complete Kits. Made of aluminum and steel.

FR Support porte brochures en aluminium et métal. D'assemblage facile, plusieurs configurations sont possibles.

PT Sistema completo de porta-folhetos e/ou marcos. Os display fornecem-se em kits completos. Fabricados em alumínio e aço.

ES Sistema completo de portafolletos y/o portagráficas. Los displays se suministran en Kits completos y están realizados en aluminio y acero.

Combi

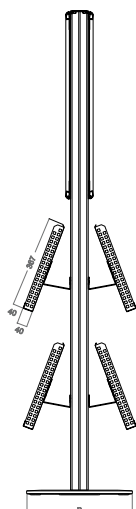
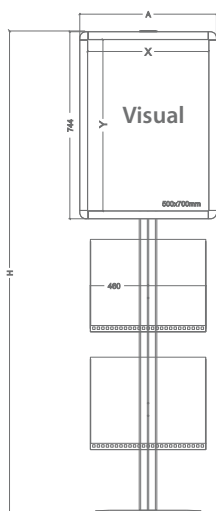

Combi One



Combi Two



	QTY	N.W	G.W	C.B.M.	Tamaño (WxHxD)
Paquete	1 Unit	2.8kg	3.6kg	0.0123	80x80x1920mm
	1 Unit	8.2kg	8.5kg	0.0097	440x50x440mm
	1 Unit	1.95kg	2.2kg	0.0089	380x50x470mm
	1 Unit	1.95kg	2.4kg	0.0104	560x25x745mm
	Visual (X-Y)		Total (B-H-A)		
Tamaño	481x681mm		Ø420x1922x544mm		

10.479 **COMBI ONE - 1**
Gráfica: 500x700mm

	QTY	N.W	G.W	C.B.M.	Tamaño (WxHxD)
Paquete	1 Unit	2.8kg	3.6kg	0.0123	80x80x1920mm
	1 Unit	8.2kg	8.5kg	0.0097	440x50x440mm
	2 Units	1.95kg	2.2kg	0.0089	380x50x470mm
	2 Units	1.95kg	2.4kg	0.0104	560x25x745mm
	Visual (X-Y)		Total (B-H-A)		
Tamaño	481x681mm		Ø420x1922x544mm		

10.480 **COMBI ONE - 2**
Gráfica: 500x700mm

	QTY	N.W	G.W	C.B.M.	Tamaño (WxHxD)
Paquete	1 Unit	2.8kg	3.6kg	0.0123	80x80x1920mm
	1 Unit	8.2kg	8.5kg	0.0097	440x50x440mm
	2 Units	1.95kg	2.2kg	0.0089	380x50x470mm
	1 Unit	1.95kg	2.4kg	0.0104	560x25x745mm
	Visual (X-Y)		Total (B-H-A)		
Tamaño	481x681mm		Ø420x1922x544mm		

10.485 **COMBI TWO - 1**
Gráfica: 500x700mm

	QTY	N.W	G.W	C.B.M.	Tamaño (WxHxD)
Paquete	1 Unit	2.8kg	3.6kg	0.0123	80x80x1920mm
	1 Unit	8.2kg	8.5kg	0.0097	440x50x440mm
	4 Units	1.95kg	2.2kg	0.0089	380x50x470mm
	2 Units	1.95kg	2.4kg	0.0104	560x25x745mm
	Visual (X-Y)		Total (B-H-A)		
Tamaño	481x681mm		Ø420x1922x544mm		

10.486 **COMBI TWO - 2**
Gráfica: 500x700mm

* W: Width H: Height D: Depth

PortaFolletos - PortaCatálogos

Combi   

Combi Three



	QTY	N.W	G.W	C.B.M.	Tamaño (WxHxD)
Paquete	1 Unit	2.8kg	3.6kg	0.0123	80x80x1920mm
	1 Unit	8.2kg	8.5kg	0.0097	440x50x440mm
	3 Units	1.95kg	2.2kg	0.0089	380x50x470mm
	Total (B-H-A)				
Tamaño	Ø420x1922x460mm				
10.483 COMBI THREE - 1					
	QTY	N.W	G.W	C.B.M.	Tamaño (WxHxD)
Paquete	1 Unit	2.8kg	3.6kg	0.0123	80x80x1920mm
	1 Unit	8.2kg	8.5kg	0.0097	440x50x440mm
	6 Units	1.95kg	2.2kg	0.0089	380x50x470mm
	Total (B-H-A)				
Tamaño	Ø420x1922x460mm				
10.484 COMBI THREE - 2					

* W: Width H: Height D: Depth

Combi Four



	QTY	N.W	G.W	C.B.M.	Tamaño (WxHxD)
Paquete	1 Unit	2.8kg	3.6kg	0.0123	80x80x1920mm
	1 Unit	8.2kg	8.5kg	0.0097	440x50x440mm
	4 Units	1.95kg	2.2kg	0.0089	380x50x470mm
	Total (B-H-A)				
Tamaño	Ø420x1922x460mm				
10.481 COMBI FOUR - 1					
	QTY	N.W	G.W	C.B.M.	Tamaño (WxHxD)
Paquete	1 Unit	2.8kg	3.6kg	0.0123	80x80x1920mm
	1 Unit	8.2kg	8.5kg	0.0097	440x50x440mm
	8 Units	1.95kg	2.2kg	0.0089	380x50x470mm
	Total (B-H-A)				
Tamaño	Ø420x1922x460mm				
10.482 COMBI FOUR - 2					

Combi Mix



	QTY	N.W	G.W	C.B.M.	Tamaño (WxHxD)
Paquete	1 Unit	2.8kg	3.6kg	0.0123	80x80x1920mm
	1 Unit	8.2kg	8.5kg	0.0097	440x50x440mm
	3 Units	1.95kg	2.2kg	0.0089	380x50x470mm
	1 Unit	1kg	1.2kg	0.0061	365x35x480mm
	Visual (X-Y)		Total (B-H-A)		
Tamaño	278x402mm		Ø420x1922x460mm		
10.487 COMBI MIX - 1 Gráfica: A3					
	QTY	N.W	G.W	C.B.M.	Tamaño (WxHxD)
Paquete	1 Unit	2.8kg	3.6kg	0.0123	80x80x1920mm
	1 Unit	8.2kg	8.5kg	0.0097	440x50x440mm
	6 Units	1.95kg	2.2kg	0.0089	380x50x470mm
	2 Units	1kg	1.2kg	0.0061	365x35x480mm
	Visual (X-Y)		Total (B-H-A)		
Tamaño	278x402mm		Ø420x1922x460mm		
10.488 COMBI MIX - 2 Gráfica: A3					

* W: Width H: Height D: Depth

Combi Frame



	QTY	N.W	G.W	C.B.M.	Tamaño (WxHxD)
Paquete	1 Unit	2.8kg	3.6kg	0.0123	80x80x1920mm
	1 Unit	8.2kg	8.5kg	0.0097	440x50x440mm
	2 Units	1.95kg	2.4kg	0.0104	560x25x745mm
	Visual (X-Y)		Total (B-H-A)		
Tamaño	481x681mm		Ø420x1922x544mm		
10.489 COMBI FRAME - 1 Gráfica: 500x700mm					
	QTY	N.W	G.W	C.B.M.	Tamaño (WxHxD)
Paquete	1 Unit	2.8kg	3.6kg	0.0123	80x80x1920mm
	1 Unit	8.2kg	8.5kg	0.0097	440x50x440mm
	4 Units	1.95kg	2.4kg	0.0104	560x25x745mm
	Visual (X-Y)		Total (B-H-A)		
Tamaño	481x681mm		Ø420x1922x544mm		
10.490 COMBI FRAME - 2 Gráfica: 500x700mm					

PortaFolletos - PortaCatálogos

Menu Stand 

Sligo

metálico

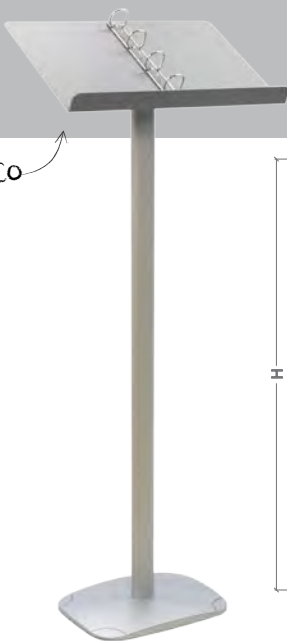

Ref.: 10.984



Sligo

acrílico

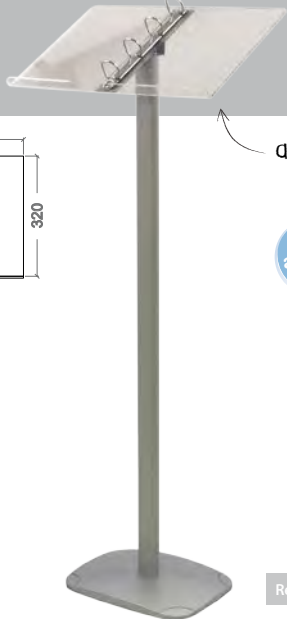

Ref.: 10.983

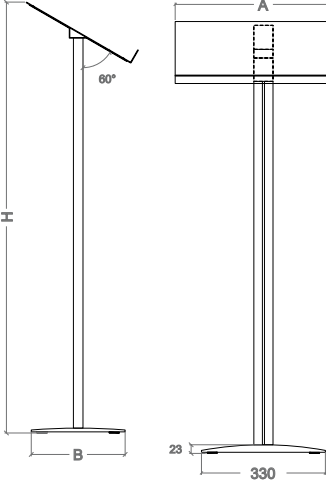

tamaño
2x A4

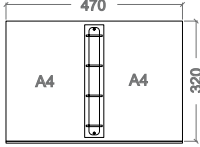



	QTY	N.W	G.W	C.B.M.	Tamaño (WxHxD)
Paquete	1 Unit	4.3kg	4.7kg	0.0107	330x65x500mm
	1 Unit	1.15kg	1.3kg	0.0028	65x40x1070mm
	Total (B-H-A)				
Tamaño	250x1147x470mm				
10.984	Metálico - 2 x A4				

	QTY	N.W	G.W	C.B.M.	Tamaño (WxHxD)
Paquete	1 Unit	2.75kg	3kg	0.0107	330x65x500mm
	1 Unit	1.15kg	1.3kg	0.0028	65x40x1070mm
	Total (B-H-A)				
Tamaño	250x1147x470mm				
10.983	Acrílico - 2 x A4				

* W: Width H: Height D: Depth

Solana





EN Extendable aluminium tripod. Ideal for placement of frames.

FR Trépied extensible, en aluminium. Idéal pour y placer des cadres.

PT Tripé extensível em alumínio. Ideal para colocação de marcos.

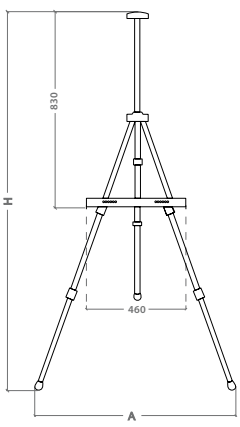
ES Trípode extensible, en aluminio. Ideal para la colocación de marcos.



telescopic





	QTY	N.W	G.W	C.B.M.	Tamaño (WxHxD)
Paquete	1	0.65kg	0.75kg	0.0035	80x80x560mm
	Total (H-A)				
Tamaño	780-1605 x900mm				
10.816	Altura: 1605mm Max.				

* Frame not included. Cadre non inclus. Marco não incluído. Marco no incluido.

* W: Width H: Height D: Depth

Soporte Pie Tablet

Tablet Stand



EN Tablet stand with lock. Made in black lacquered aluminum, steel and plastic parts.
FR Support pour tablette avec serrure. Fabriqué en aluminium noir laqué, acier et pièces en plastique.

PT Suporte para Tablet com fechadura. Fabricado em alumínio lacado a preto, aço e plástico.
ES Soporte para Tablet con cerradura. Fabricado en aluminio lacado en negro, acero y partes de plástico.

Tablet Stand



NEW

360°
rotación

foam
protectores

*tablet no
incluida

ajustable

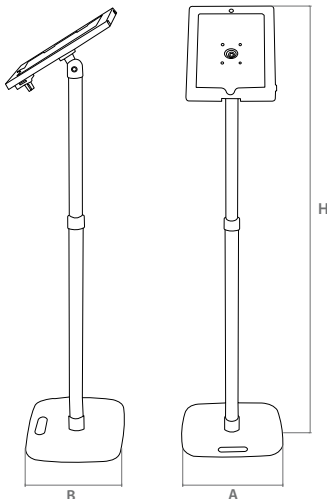

	QTY	N.W	G.W	C.B.M.	Tamaño (WxHxD)
Paquete	1 Unit	4kg	4.25kg	0.037	395x125x760mm
	Total (B-H-A)				
Tamaño	245x1350x280mm				
10.306	Safety Holder for Tablet 242.8x189.7mm				

* W: Width H: Height D: Depth

PortaFolletos - PortaCatálogos

Brochure Stand  

EN Brochure and catalogue stands for A4 format, made in different sizes and materials.

FR Support pour brochure et catalogue au format A4, fabriqué en différentes tailles et matériaux.

PT Porta folhetos ou catálogos em formato A4. Disponíveis em vários tamanhos e materiais.

ES Portafolletos y portacatálogos para formato A4, realizados en diferentes materiales y tamaños.

Sagres

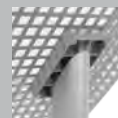

A4 formato



Ref.: 10.473

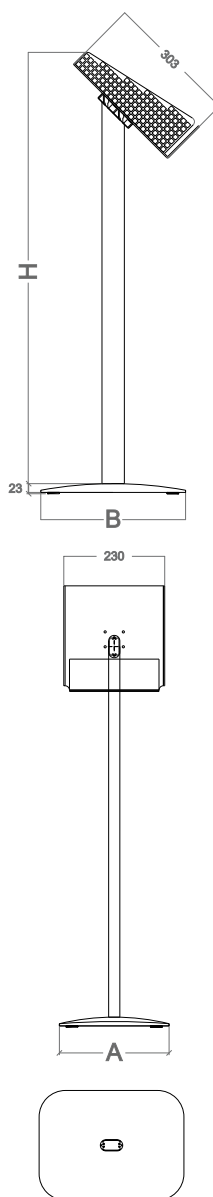

Ref.: 10.474

	QTY	N.W	G.W	C.B.M.	Tamaño (WxHxD)
Paquete	1 Unit	3.1kg	3.4kg	0.0322	295x120x910
	Total (B-H-A)				
Tamaño	330x 1000x250mm				
10.473	Acrílico				

a

	QTY	N.W	G.W	C.B.M.	Tamaño (WxHxD)
Paquete	1 Unit	3.2kg	3.5kg	0.0322	295x120x910mm
	Total (B-H-A)				
Tamaño	330x 1000x250mm				
10.474	Metal				

* W: Width H: Height D: Depth

Portafolletos - Urna para Stand

Leaflet Dispenser Stand | Ballot Box Stand



EN Leaflet dispenser and ballot box stands made in acrylic and aluminium structure. Decorative interchangeable cover for the base.
FR Porte-brochure avec un support pour urne fabriqué en acrylique et aluminium. L'élément décoratif du socle est interchangeable.

PT Porta-folhetos com suporte para urna, fabricado em acrílico e alumínio. Possui um elemento decorativo na base que se pode mudar.
ES Portafolletos y stand para urna, realizados en acrílico y estructura en aluminio. Elemento decorativo intercambiable para la base.

Dispensador para Stand



Urna para Stand



polietileno

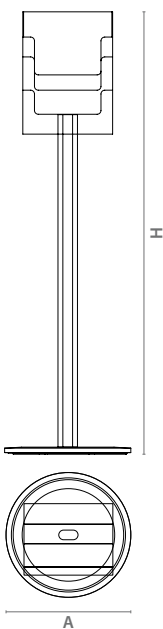

Ref.: 14.100



+ 2 extra discs included

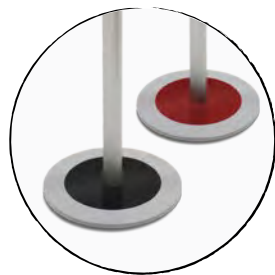

suministrado con 2 discos extras intercambiables (Color negro y rojo)

acrílico

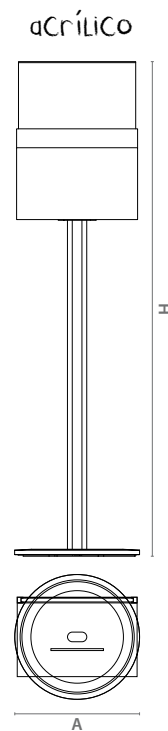

Ref.: 14.101

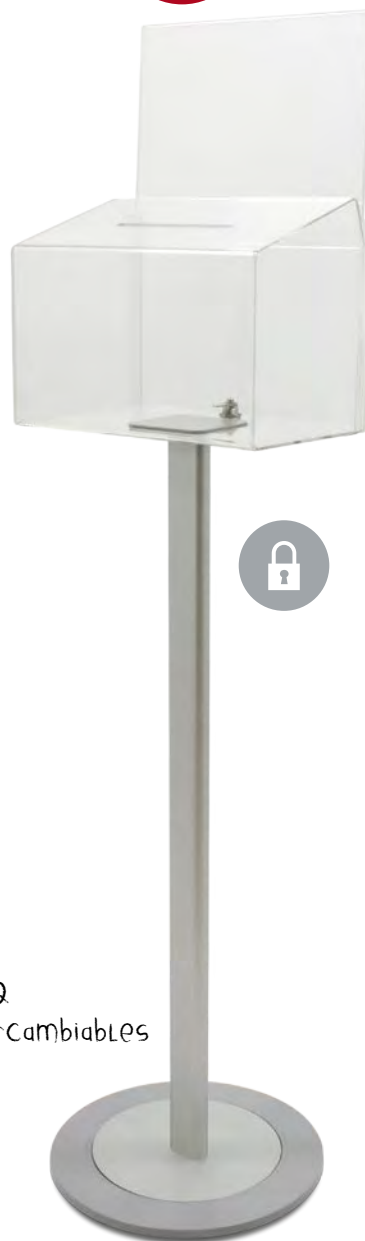

	QTY	N.W	G.W	C.B.M.	Tamaño (WxHxD)
Base	1	5kg	5.3kg	0.0055	350x350x45
Pie	1	0.7kg	0.85kg	0.0035	895x65x37
Dispensador	1	1.1kg	1.5kg	0.0197	330x230x260
	Total (B-H-A)				
Tamaño	1170xØ330mm				
14.100	Dispensador Stand				

	QTY	N.W	G.W	C.B.M.	Tamaño (WxHxD)
Base	1	5kg	5.3kg	0.0055	350x350x45
Pie	1	0.7kg	0.85kg	0.0035	895x65x37
Urna	1	1.7kg	2.4kg	0.0332	380x265x330
	Total (H-A)				
Tamaño	1323xØ330mm				
14.101	Urna Stand				

* W: Width H: Height D: Depth



PortaFolletos - PortaCatálogos

Brochure Stand  

Bari

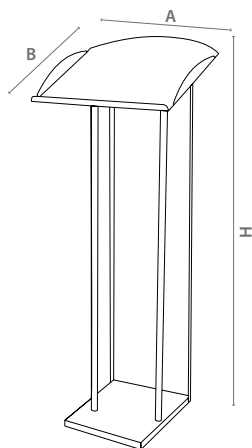

A4 formato

	QTY	N.W	G.W	C.B.M.	Tamaño (WxHxD)
Paquete	1 Unit	8.6kg	11kg	0.3125	500x500x1250mm
	Total (B-H-A)				
Tamaño	450x1210x455mm				
10.219					



* W: Width H: Height D: Depth



espacio superior para 2xA4

ideal para catálogos

Vegas

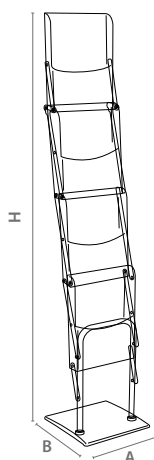

A4 formato

Plegable



	QTY	N.W	G.W	C.B.M.	Tamaño (WxHxD)
Paquete	1 Unit	6kg	8kg	0.067	380x380x470mm
	Total (B-H-A)				
Tamaño	280x1605x260mm				
10.048					



* W: Width H: Height D: Depth

PortaFolletos - PortaCatálogos

Stand



Sahagun

plegable

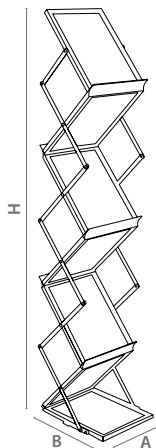

5x A4
vertical

maleta
incluida

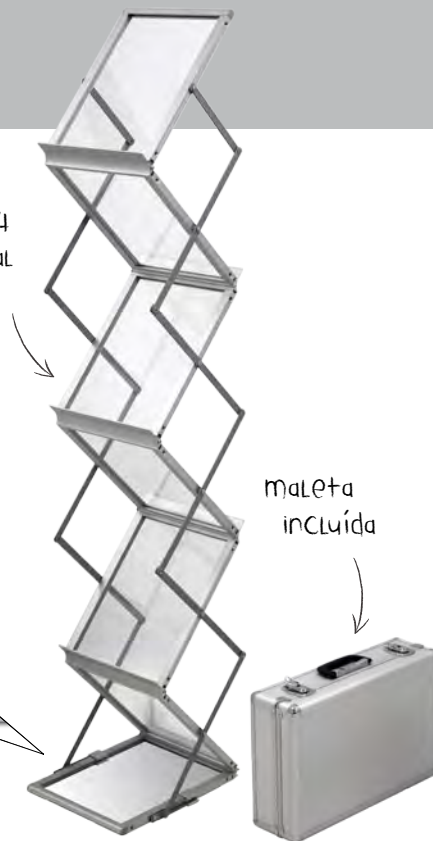

	QTY	N.W	G.W	C.B.M.	Tamaño (WxHxD)
Paquete	1 Unit	7.35kg	7.95kg	0.0293	360x170x480mm
	Total (B-H-A)				
Tamaño	350x1490x260mm				
10.047					



* W: Width H: Height D: Depth

Soubran

plegable

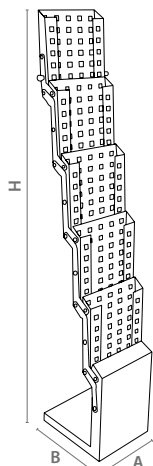

5x A4
vertical

el pie puede
ser usado
para guardar
folletos

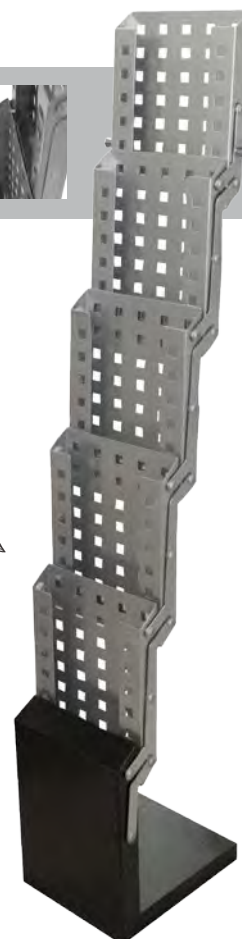

	QTY	N.W	G.W	C.B.M.	Tamaño (WxHxD)
Paquete	1 Unit	32kg	34kg	0.148	550x350x770mm
	Total (B-H-A)				
Tamaño	290x1420x230mm				
10.416					



* W: Width H: Height D: Depth

PortaFolletos - PortaCatálogos

Stand



Mentrida

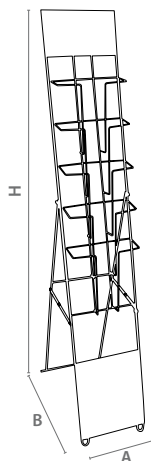

5x A4
vertical

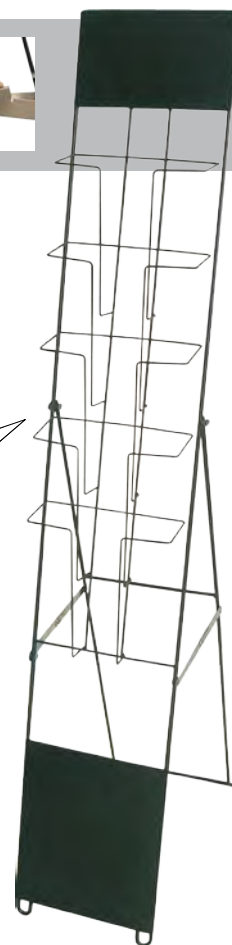
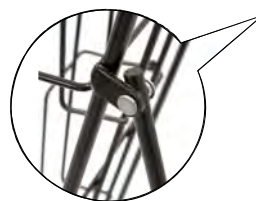

	QTY	N.W	G.W	C.B.M.	Tamaño (WxHxD)
Paquete	1 Unit	4.2kg	5.1kg	0.0565	310x120x1520mm
	Total (B-H-A)				
Tamaño	470x1465x250mm				
10.720					



* W: Width H: Height D: Depth

Bañeza

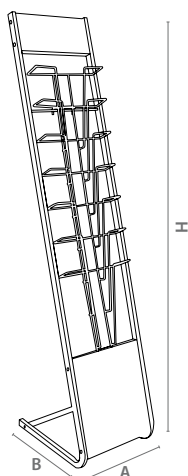

7x A4
vertical



	QTY	N.W	G.W	C.B.M.	Tamaño (WxHxD)
Paquete	1 Unit	2.9kg	3.6kg	0.0532	375x100x1420mm
	Total (B-H-A)				
Tamaño	370 x1370x280mm				
10.044					



* W: Width H: Height D: Depth

PortaFolletos - PortaCatálogos

Stand



Sil



simple

doble

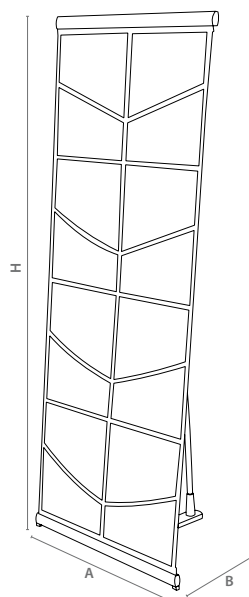
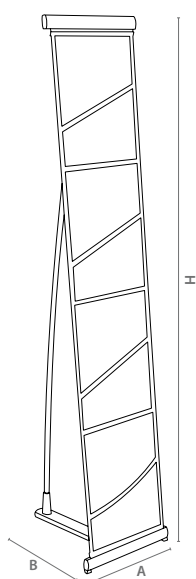

rápido y simple
montaje

Ref.: 10.051

Ref.: 10.050

	QTY	N.W	G.W	C.B.M.	Tamaño (WxHxD)
Paquete	1 Unit	1.05kg	1.20kg	0.0086	120x120x600mm
	Total (B-H-A)				
Tamaño	380x1360x270mm				
10.051	Simple				



	QTY	N.W	G.W	C.B.M.	Tamaño (WxHxD)
Paquete	1 Unit	1.4kg	1.55kg	0.0086	120x120x600mm
	Total (B-H-A)				
Tamaño	380x1360x545mm				
10.050	Doble				



* W: Width H: Height D: Depth

PortaFolletos - PortaCatálogos

Stand



Legnica

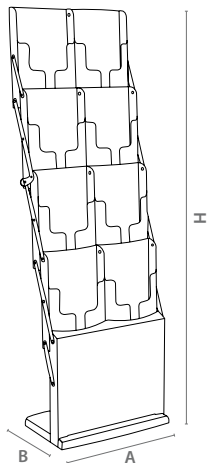

8x A4
vertical



	QTY	N.W	G.W	C.B.M.	Tamaño (WxHxD)
Paquete	1 Unit	14.4kg	15.5kg	0.109	540x355x570mm
	Total (B-H-A)				
Tamaño	300x1560x480mm				
10.114	Doble				



* W: Width H: Height D: Depth

Nelas

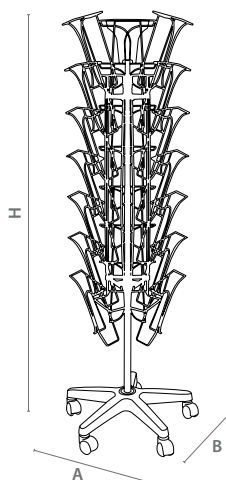

21x A4
vertical

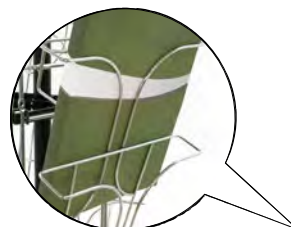

con
ruedas

	QTY	N.W	G.W	C.B.M.	Tamaño (WxHxD)
Paquete	1 Unit	8kg	10.05kg	0.203	530x320x1200mm
	Total (B-H-A)				
Tamaño	510x1550x510mm				
13.101					

* W: Width H: Height D: Depth

PortaFolletos - PortaCatálogos

Stand



Cañamo

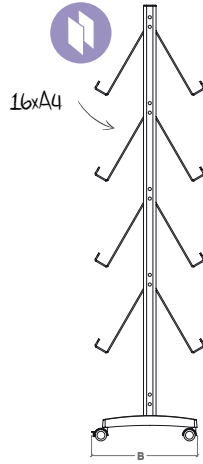
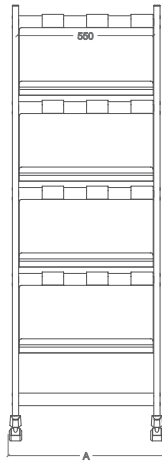
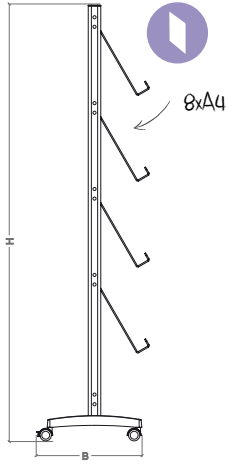

2 caras disponible

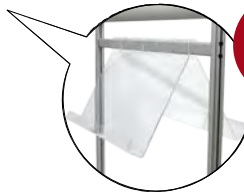

NEW



freno ruedas

	QTY	N.W	G.W	C.B.M.	Tamaño (WxHxD)
Paquete	1 Unit	7.3kg	9kg	0.0487	410x165x720mm
	1 Unit	6.45kg	8.05kg	0.0772	630x70x1750mm
	Total (B-H-A)				
Tamaño	487x1769x629mm				
10.468	1 cara (8xA4)				
14.098	2 caras (16xA4)				

* W: Width H: Height D: Depth

Abad

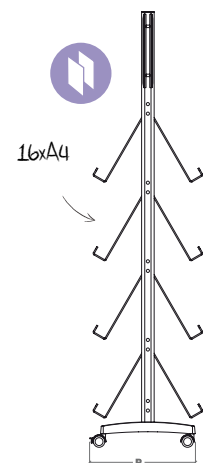
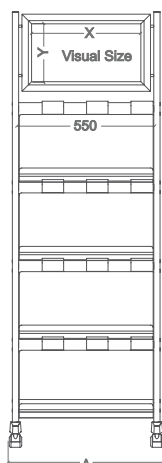
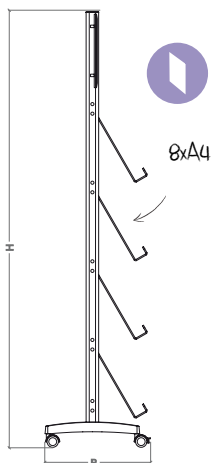

2 caras disponible



NEW

EN	Includes "Click" aluminium frame at the top.
FR	Avec un cadre "Click" dans la partie supérieure.
PT	Possui um marco de abertura "Click" na parte superior.
ES	Dispone de un marco "Click" en su parte superior.



freno ruedas

	QTY	N.W	G.W	C.B.M.	Tamaño (WxHxD)
Paquete	1 Unit	7.3kg	9kg	0.0487	410x165x720mm
	1 Unit	6.45kg	8.05kg	0.0772	630x70x1750mm
	Visual (X-Y)		Total (B-H-A)		
Tamaño	466x236mm				
	487x1769x629mm				
10.467	Gráfica: 460x260mm				
14.099	Gráfica: 460x260mm x2				

* W: Width H: Height D: Depth

PortaFolletos - PortaCatálogos

Stand



Sotillo

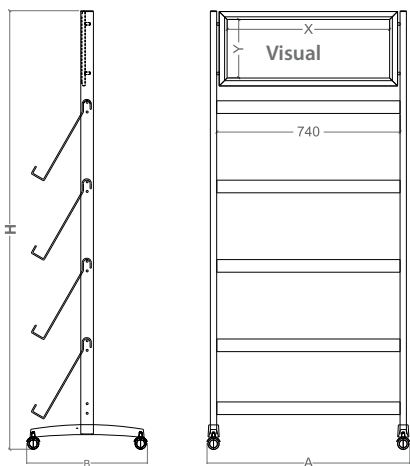

- EN Includes "Click" aluminium frame at the top.
- FR Avec un cadre "Click" dans la partie supérieure.
- PT Possui um marco de abertura "Click" na parte superior.
- ES Dispone de un marco "Click" en su parte superior.

12x A4

3x A4
por estante

	QTY	N.W	G.W	C.B.M.	Tamaño (WxHxD)
Paquete	1 Unit	9kg	10.5kg	0.062	410x165x920mm
	1 Unit	7.35kg	9.35kg	0.101	830x70x1750mm
	Visual (X-Y)	Total (B-H-A)			
Tamaño	656x236mm		487x1769x819mm		
10.469	Gráfica: 666x246mm				

* W: Width H: Height D: Depth



freno ruedas



Olmedilla

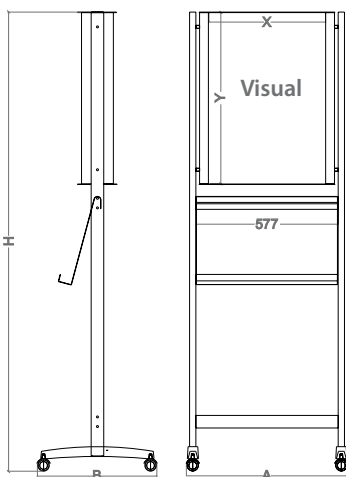

- EN Includes "Click" aluminium frame at the top.
- FR Avec un cadre "Click" dans la partie supérieure.
- PT Possui um marco de abertura "Click" na parte superior.
- ES Dispone de un marco "Click" en su parte superior.

dos
Caras



freno ruedas

3x A4 per shelf

	QTY	N.W	G.W	C.B.M.	Tamaño (WxHxD)
Paquete	1	11.5kg	13.4kg	0.243	650x205x1825mm
	Visual (X-Y)	Total (B-H-A)			
Tamaño	476x696mm		487x1864x655mm		
10.472	Graphic Size: 500x700mm				

* W: Width H: Height D: Depth

	QTY	N.W	G.W	C.B.M.	Tamaño (WxHxD)
Paquete	1	17kg	18.5kg	0.372	850x240x1825mm
	Visual (X-Y)	Total (B-H-A)			
Tamaño	690x996mm		487x1864x856mm		
10.273	Graphic Size: 700x1000mm				

* W: Width H: Height D: Depth

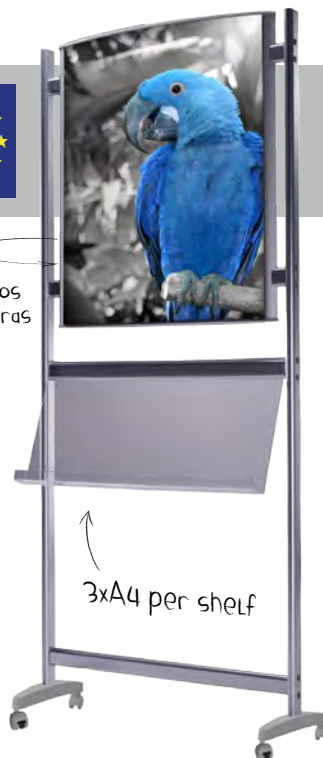

PortaFolletos - PortaCatálogos

Stand



Verona
4x4

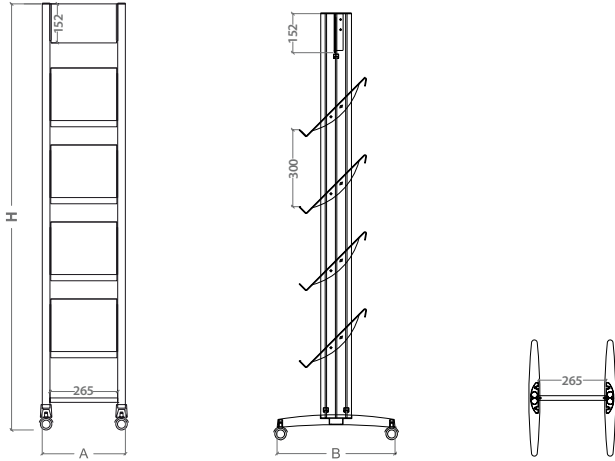

	QTY	N.W	G.W	C.B.M.	Tamaño (WxHxD)
Paquete	1 Unit	3kg	3.95kg	0.0307	420x170x430mm
	1 Unit	4.45kg	5kg	0.0188	145x80x1620mm
		Total (B-H-A)			
Tamaño	380x1660x325mm				
10.217	Gráfica: 255x147mm				

* W: Width H: Height D: Depth

para 4x4



Verona
12x4

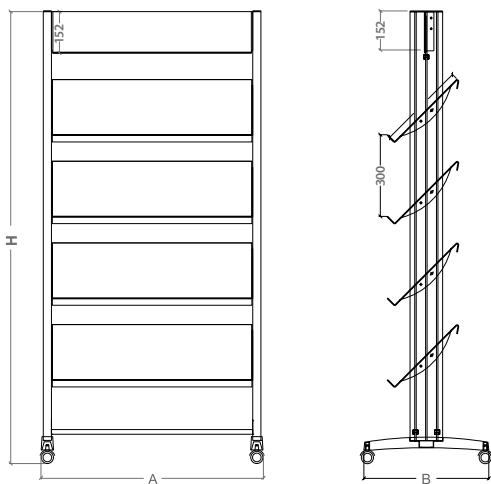

	QTY	N.W	G.W	C.B.M.	Tamaño (WxHxD)
Paquete	1 Unit	3kg	3.95kg	0.0307	420x170x430mm
	1 Unit	4.45kg	5kg	0.0188	145x80x1620mm
		Total (B-H-A)			
Tamaño	380x1660x800mm				
10.218	Gráfica: 730x147mm				

* W: Width H: Height D: Depth

para 12x4



PortaFolletos - PortaCatálogos

Stand



Athy



- EN Wall-mounted leaflet dispenser. Made of aluminum and methacrylate. Capacity 8x A4.
- FR Porte brochures à fixer au mur, fabriqué en aluminium et acrylique. Capacité 8x A4.
- PT Porta-catálogos de parede, fabricado em alumínio e acrílico. Capacidade de 8x A4.
- ES Portafolletos a pared, realizado en aluminio y metacrilato. Con capacidad para 8x A4.

para 8x A4



2x A4
por estante

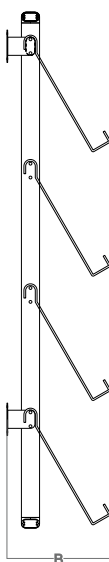
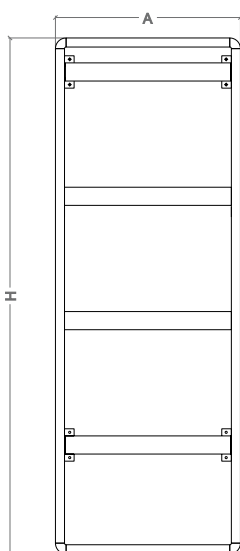
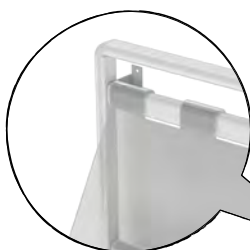

	QTY	N.W	G.W	C.B.M.	Tamaño (WxHxD)
Paquete	1	11.7kg	13.4kg	0.1742	650x185x1500mm
		Total (B-H-A)			
Tamaño	290x1450x520mm				
10.988					

* W: Width H: Height D: Depth

PortaFolletos - PortaCatálogos

Stand



Cañada

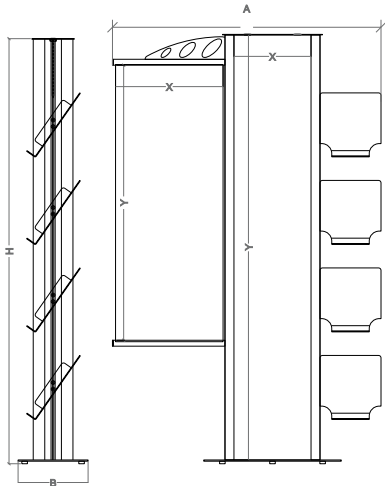

con luz LED

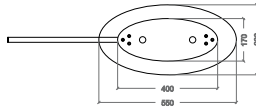

doble Cara



	QTY	N.W	G.W	C.B.M.	Tamaño (WxHxD)
Paquete	1 Unit	18.5kg	19.7kg	0.3752	652x345x1740mm
		Visual (X-Y)		Total (B-H-A)	
Tamaño		Totem-308x1699mm Poster-430x1109mm		280x1700x1074mm	
10.470		Totem - Gráfica: 324x1700mm Poster - Gráfica: 430x1100mm			



* W: Width H: Height D: Depth

Hito

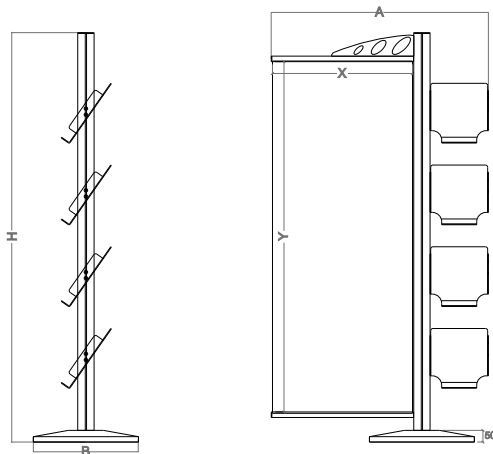
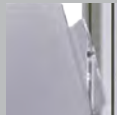

3xA4



	QTY	N.W	G.W	C.B.M.	Tamaño (WxHxD)
Paquete	1 Unit	2.8kg	3.6kg	0.0123	80x80x1920mm
	1 Unit	8.2kg	8.5kg	0.0097	440x50x440mm
	1 Unit	1.6kg	1.9kg	0.0190	390x75x650mm
		Visual (X-Y)		Total (B-H-A)	
Tamaño		600x1500mm		450x1753x930mm	
10.471		Gráfica: 600x1510mm			



10 kg base de acero

doble Cara

* W: Width H: Height D: Depth



La Cartelera y el Equipamiento Comercial, SL

Calle Luis I, Nave 45 A

Polígono Industrial de Vallecas
28031 Madrid

Teléfono: 913 805 532

Móvil: 678 513 395



This catalogue is not a contractual document, therefore Cashdisplay is not responsible for any typographical or printing mistakes. Prices valid until 31st October of 2016. Prices may change at any time for updating prices.

- VAT, sales taxes or duty taxes are not included in the sale price.
- All prices are per unit, unless indicated otherwise.
- Assembly is not included.
- GRAPHIC IS NOT INCLUDED IN THE ITEM PRICE.
- FREIGHT/TRANSPORT IS NOT INCLUDED, Cashdisplay is not responsible for any delays or any problems related to the transportation of products, only the transport company will be held liable.
- Verify the size and measurements of the printed graphic before assembling any display.
- Discounts: For purchases above 5,000€ = 10% discount. For purchases above 10,000€ = 20% discount. There are special discounts for the purchase of large quantities of the same item, please consult us. Discounts cannot be used in combination with other promotions.
- Products will remain in our warehouses until we have the verification of payment from your bank.
- Please check our stock before your purchase. All products may not be available in every country where Cashdisplay is present.



Le présent catalogue n'est pas un document contractuel. Cashdisplay ne serait être responsable des possibles erreurs typographiques. Prix valables jusqu'au 31 Octobre 2016 (sous réserve d'une information de notre part vous notifiant des modifications de prix avant cette date).

- La TVA et impôts spéciaux ne sont pas inclus dans les prix du présent catalogue.
- Prix unitaires, sauf indication contraire.
- Montage non inclus.
- IMPRESSIONS NON INCLUSES, les dimensions sont en millimètres.
- TRANSPORT NON INCLUS. Cashdisplay ne serait être tenu responsable des retards ou autres incidents de transport, ceux-ci seront de la responsabilité du client.
- Remarque: vérifiez les mesures d'impression des articles avant son montage.
- Remises: facture supérieure à 5.000€ remise de 10%; Facture supérieure à 10.000€ remise de 20%. Pour de grandes quantités d'un article, consultez les remises quantitatives. Remises non cumulables entre elles.
- La marchandise restera dans les entrepôts de Cashdisplay jusqu'à la vérification du paiement par notre banque.
- Assurez-vous de la disponibilité des produits avant toute commande. Les articles ne sont pas disponibles dans tous les pays où Cashdisplay est présent.



O presente catálogo não é um documento contratual, pelo que a Cashdisplay não se responsabiliza perante possíveis erros tipográficos. Preços válido até 31 de Outubro de 2016 (excepto se existir comunicação da alterações de preços antes).

- O IVA e impostos especiais NÃO estão incluídos nos preços do presente catálogo.
- Preços unitários, excepto indicação contrária.
- Montagem NÃO incluída.
- IMPRESSÕES NÃO INCLuíDAS, as medidas estão em milímetros.
- TRANSPORTE: NÃO INCLuíDO. A Cashdisplay não se responsabiliza pelos atrasos ou outras incidências de transporte, estas serão da responsabilidade do contratante do referente serviço.
- Nota: Verifique as medidas de impressão do artigo, antes da sua montagem.
- Descontos: Factura superior a 5.000€, desconto de 10%. Factura superior a 10.000€, desconto de 20%. Para grandes quantidades de um artigo, consultar "Tabela de descontos". Descontos não acumuláveis entre si.
- A mercadoria permanecerá nos armazéns da Cashdisplay até se verificar a entrada de valor em conta.
- Consulte a disponibilidade dos artigos antes de realizar o seu pedido. Nem todos os artigos estão disponíveis em todos os países em que a Cashdisplay está presente.



El presente catálogo no es un documento contractual, por lo que Cashdisplay no se responsabiliza ante posibles errores tipográficos. Precios válidos hasta el 31 de Octubre del 2016 (salvo comunicación de cambios de precios antes de esa fecha).

- IVA e impuestos especiales no están incluidos en los precios del presente catálogo.
- Precios unitarios, excepto si se indica lo contrario.
- Montajes no incluidos.
- GRÁFICAS NO INCLUIDAS EN LOS PRECIOS.
- TRANSPORTE: NO INCLUIDO. Cashdisplay no se responsabiliza de retrasos u otras incidencias derivadas del transporte, estas serán por cuenta del contratante de dicho servicio.
- Verifique las medidas de impresión sobre el display, antes del montaje.
- Descuentos: facturas superiores a 5.000€ de compra descuento de un 10%, facturas superiores a 10.000€ descuento de un 20%. Para grandes cantidades de un artículo, consulte descuentos por volumen. Descuentos no acumulables entre sí o a otras promociones vigentes.
- La mercancía permanecerá en los almacenes de Cashdisplay hasta disponer de la verificación del pago por parte de nuestro banco.
- Consulte la disponibilidad de los artículos antes de realizar su pedido. Todos los artículos no se encuentran disponibles en todos los países en los que Cashdisplay está presente.

	EN	FR	PT	ES
	Carry bag included	Avec sac de transport	Inclui bolsa de transporte	Incluye bolsa de transporte
	One sided	Une face	Uma face	Una cara
	Double-Sided	Double face	Dupla face	Doble cara
	With motion	Avec mouvement	Com movimento	Con movimiento
	With light	Eclairé	Com luz	Con luz
	LED Technology	Technologie LED	Tecnologia LED	Tecnología LED
	Telescopic	Télescopique	Telescópico	Telescópico
	Printed on fabric	Impression sur toile	Impressão têxtil	Impresión sobre textil
	With lock	Avec serrure	Com fechadura	Con cerradura
	Rainproof	Imperméable	Impermeável	Impermeable
	Suitable for outdoor use	Pour l'extérieur	Para exterior	Para exterior
	With spotlights	Avec spot	Com focos	Focos incluidos
	With Adhesive	Avec adhésif	Con adesivo	Con adhesivo
	Cardboard	Carton	Cartão	Cartón
	With suction pad	Avec ventouse	Com ventosa	Con ventosa
	New Item	Nouvel article	Novidade	Producto nuevo
	Lightweight	Poids léger	Leve	Ligero
	Extraweight	Poids supplémentaire	Peso extra	Peso extra
	Flexible	Flexible	Flexível	Basculante
	Magnetic	Aimanté	Magnético	Magnético
	Plug-in	A Brancher	Elétrico	A corriente
	Big Sizes	Grandes tailles	De grandes dimensões	Grandes dimensiones
	Portrait	Verticale	Vertical	Vertical
	Landscape	Horizontale	Horizontal	Horizontal
	Portrait / Landscape	Vertical ou horizontal	Vertical ou horizontal	Vertical u Horizontal
	"Click" System	Système "Click"	Sistema "Click"	Sistema "Click"
	With Velcro	Avec velcro	Com Velcro	Con velcro
	Acrylic	Acrylique	Acrílico	Acrílico
	Economic	Économique	Económico	Económico
	Tools required	Outils nécessaire	Montagem com ferramentas	Requiere herramientas
	No tools required	Aucun outil requis	Montagem sem ferramentas	No requiere herramientas
QTY	Quantity	Quantité	Quantidade	Cantidad
NW	Net weight	Poids net	Peso líquido	Peso neto
GW	Gross weight	Poids brut	Peso bruto	Peso bruto
CBM	Cubic meter	Metres cubes	Metro cúbico	Metro cúbico
Size	Measures	Mesures.	Medidas	Medidas