



2015
2016



La Cartelera y el Equipamiento Comercial, SL

Calle Luis I, Nave 45 A
Polígono Industrial de Vallecas
28031 Madrid

Teléfono: 913 805 532
Móvil: 678 513 395



This catalogue is not a contractual document, therefore Cashdisplay is not responsible for any typographical or printing mistakes. Prices valid until 31st October of 2016. Prices may change at any time for updating prices.

- VAT, sales taxes or duty taxes are not included in the sale price.
- All prices are per unit, unless indicated otherwise.
- Assembly is not included.
- GRAPHIC IS NOT INCLUDED IN THE ITEM PRICE.
- FREIGHT/TRANSPORT IS NOT INCLUDED. Cashdisplay is not responsible for any delays or any problems related to the transportation of products, only the transport company will be held liable.
- Verify the size and measurements of the printed graphic before assembling any display.
- Discounts: For purchases above 5,000€ = 10% discount. For purchases above 10,000€ = 20% discount. There are special discounts for the purchase of large quantities of the same item, please consult us. Discounts cannot be used in combination with other promotions.
- Products will remain in our warehouses until we have the verification of payment from your bank.
- Please check our stock before your purchase. All products may not be available in every country where Cashdisplay is present.



Le présent catalogue n'est pas un document contractuel. Cashdisplay ne serait être responsable des possibles erreurs typographiques. Prix valables jusqu'au 31 Octobre 2016 (sous réserve d'une information de notre part vous notifiant des modifications de prix avant cette date).

- La TVA et impôts spéciaux ne sont pas inclus dans les prix du présent catalogue.
- Prix unitaires, sauf indication contraire.
- Montage non inclus.
- IMPRESSIONS NON INCLUSES, les dimensions sont en millimètres.
- TRANSPORT NON INCLUS. Cashdisplay ne serait être tenu responsable des retards ou autres incidents de transport, ceux-ci seront de la responsabilité du client.
- Remarque: vérifiez les mesures d'impression des articles avant son montage.
- Remises: facture supérieure à 5.000€ remise de 10%; Facture supérieure à 10.000€ remise de 20%. Pour de grandes quantités d'un article, consultez les remises quantitatives. Remises non cumulables entre elles.
- La marchandise restera dans les entrepôts de Cashdisplay jusqu'à la vérification du paiement par notre banque.
- Assurez-vous de la disponibilité des produits avant toute commande. Les articles ne sont pas disponibles dans tous les pays où Cashdisplay est présent.



O presente catálogo não é um documento contratual, pelo que a Cashdisplay não se responsabiliza perante possíveis erros tipográficos. Preços válido até 31 de Outubro de 2016 (excepto se existir comunicação da alterações de preços antes).

- O IVA e impostos especiais NÃO estão incluídos nos preços do presente catálogo.
- Preços unitários, excepto indicação contrária.
- Montagem NÃO incluída.
- IMPRESSÕES NÃO INCLUIDAS, as medidas estão em milímetros.
- TRANSPORTE: NÃO INCLUIDO. A Cashdisplay não se responsabiliza pelos atrasos ou outras incidências de transporte, estas serão da responsabilidade do contratante do referente serviço.
- Nota: Verifique as medidas de impressão do artigo, antes da sua montagem.
- Descontos: Factura superior a 5.000€, desconto de 10%. Factura superior a 10.000€, desconto de 20%. Para grandes quantidades de um artigo, consultar "Tabela de descontos". Descontos não acumuláveis entre si.
- A mercadoria permanecerá nos armazéns da Cashdisplay até se verificar a entrada de valor em conta.
- Consulte a disponibilidade dos artigos antes de realizar o seu pedido. Nem todos os artigos estão disponíveis em todos os países em que a Cashdisplay está presente.



El presente catálogo no es un documento contractual, por lo que Cashdisplay no se responsabiliza ante posibles errores tipográficos. Precios válidos hasta el 31 de Octubre del 2016 (salvo comunicación de cambios de precios antes de esa fecha).

- IVA e impuestos especiales no están incluidos en los precios del presente catálogo.
- Precios unitarios, excepto si se indica lo contrario.
- Montajes no incluidos.
- GRÁFICAS NO INCLUIDAS EN LOS PRECIOS.
- TRANSPORTE: NO INCLUIDO. Cashdisplay no se responsabiliza de retrasos u otras incidencias derivadas del transporte, estas serán por cuenta del contratante de dicho servicio.
- Verifique las medidas de impresión sobre el display, antes del montaje.
- Descuentos: facturas superiores a 5.000€ de compra descuento de un 10%, facturas superiores a 10.000€ descuento de un 20%. Para grandes cantidades de un artículo, consulte descuentos por volumen. Descuentos no acumulables entre sí o a otras promociones vigentes.
- La mercancía permanecerá en los almacenes de Cashdisplay hasta disponer de la verificación del pago por parte de nuestro banco.
- Consulte la disponibilidad de los artículos antes de realizar su pedido. Todos los artículos no se encuentran disponibles en todos los países en los que Cashdisplay está presente.

	EN	FR	PT	ES
	Carry bag included	Avec sac de transport	Inclui bolsa de transporte	Incluye bolsa de transporte
	One sided	Une face	Uma face	Una cara
	Double-Sided	Double face	Dupla face	Doble cara
	With motion	Avec mouvement	Con movimento	Con movimiento
	With light	Eclairé	Com luz	Con luz
	LED Technology	Technologie LED	Tecnologia LED	Tecnologia LED
	Telescopic	Télescopique	Telescópico	Telescópico
	Printed on fabric	Impression sur toile	Impressão têxtil	Impresión sobre textil
	With lock	Avec serrure	Com fechadura	Con cerradura
	Rainproof	Imperméable	Impermeável	Impermeable
	Suitable for outdoor use	Pour l'extérieur	Para exterior	Para exterior
	With spotlights	Avec spot	Com focos	Focos incluidos
	With Adhesive	Avec adhésif	Con adesivo	Con adhesivo
	Cardboard	Carton	Cartão	Cartón
	With suction pad	Avec ventouse	Com ventosa	Con ventosa
	New Item	Nouvel article	Novidade	Producto nuevo
	Lightweight	Poids léger	Leve	Ligero
	Extraweight	Poids supplémentaire	Peso extra	Peso extra
	Flexible	Flexible	Flexível	Basculante
	Magnetic	Aimanté	Magnético	Magnético
	Plug-in	A Brancher	Elétrico	A corriente
	Big Sizes	Grandes tailles	De grandes dimensões	Grandes dimensiones
	Portrait	Verticale	Vertical	Vertical
	Landscape	Horizontale	Horizontal	Horizontal
	Portrait / Landscape	Vertical ou horizontale	Vertical ou horizontal	Vertical u Horizontal
	"Click" System	Système "Click"	Sistema "Click"	Sistema "Click"
	With Velcro	Avec velcro	Com Velcro	Con velcro
	Acrylic	Acrylique	Acrílico	Acrílico
	Economic	Économique	Económico	Económico
	Tools required	Outils nécessaire	Montagem com ferramentas	Requiere herramientas
	No tools required	Aucun outil requis	Montagem sem ferramentas	No requiere herramientas
	Quantity	Quantité	Quantidade	Cantidad
	Net weight	Poids net	Peso líquido	Peso neto
	Gross weight	Poids brut	Peso bruto	Peso bruto
	Cubic meter	Metres cubes	Metro cúbico	Metro cúbico
	Measures	Mesures.	Medidas	Medidas



POSTES
conos

Poste Separador de Acero

Poste con cinta retráctil



EN Steel barrier pole with 2 metres retractable tape and 3 connection points for tapes. Dome base with 320mm diameter.
FR Poteau séparateur en acier comprenant une sangle extensible de 2m avec dispositif de sécurité et un socle.

PT Poste separador em aço com fita retráctil e 3 pontos de ligação. Base arredondada com 320 mm de diâmetro. Aço e plástico.
ES Postes separador de acero con cinta retráctil de 2 metros con dispositivo de seguridad y 3 puntos de conexión.

Poste Separador con cinta retráctil

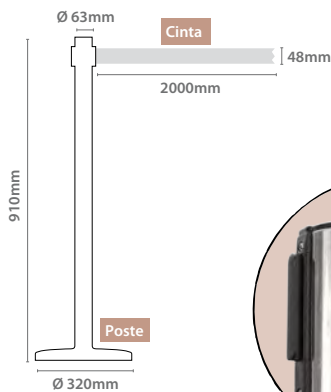

cierre de seguridad

3 puntos de conexión



Referencia	Poste	Cinta	
10.335			
10.331			
10.336			
10.330			
10.421			x2
10.904			
10.340			
10.420			

Poste Separador Metalizado

Poste con cinta retráctil



Poste Metalizado Acero con cinta retráctil

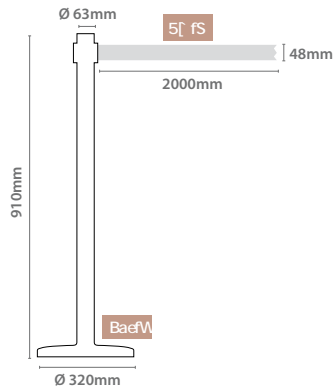

10.905

10.903

Cierre de seguridad



Referencia	Poste	Cinta	
10.903			
10.905			x2

Poste Separador Emergencia

NEW



2m Cinta

Referencia	Poste	Cinta	
13.705			x2
13.706			

Poste Separador Doble



tubo: Ø 63mm

Referencia	Poste	Cinta	Tamaño	
10.926			Ø320x910mm	
10.927			Ø320x910mm	x2
10.928			Ø320x910mm	

Poste Separador

Poste con rueda



Poste Separador con Rueda

con 3 puntos de conexión

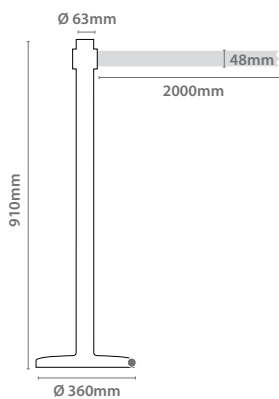

rueda en la base

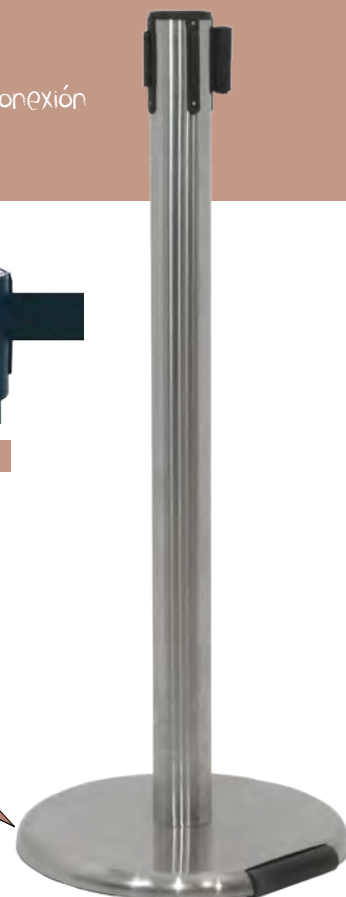
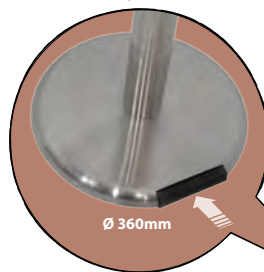

Referencia	Poste	Cinta	
10.929			
10.930			x2

Dispensador para poste

Marco Titanio para poste



Ø 200mm

10.931

Ø 300mm

10.932



10.916

10.917

Referencia	Diámetro Bol
10.931	Ø 200mm
10.932	Ø 300mm

Referencia	Color	Tamaño Marco
10.916		380x265mm
10.917		380x265mm

Soporte de Pared con Cinta

Soporte | Spare parts



EN Retractable barrier tape with wall fixing system and 2 metres length. Wall tape receiver and screws are included.

FR Sangle avec 2 mètres de long pour un montage mural. Support récepteur de sangle et vis inclus.

PT Fita retrátil com 2 metros de comprimento para fixação à parede. Suporte de recepção da fita e parafusos incluídos.

ES Cinta separadora retráctil de 2m de longitud con sistema de anclaje a pared. Incluye pieza receptora de cinta y tornillería.

Soporte de Pared con cinta



incluye conector pared



Referencia	Poste	Cinta
13.700		
13.701		
13.702		
13.703		
13.704		



Cinta de 2m



incluye conector pared

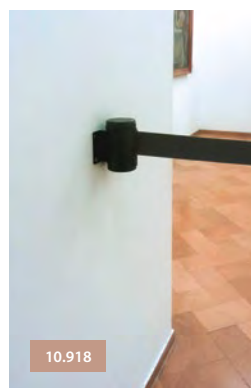

Referencia	Poste	Cinta	Tamaño
10.918			Ø63x130mm
10.975			Ø63x130mm

Conector pared



Referencia	Tamaño
10.918P	87mm

Postes para Cordón

Postes para Cordón



EN Post for lace fitted with smooth tube and base.
(Cord not included).

FR Poteau pour corde avec tube lisse et base entaillé.
(Corde non incluse).

PT Poste para cordão com tubo liso e base esculpida.
(Cordão não incluído).

ES Poste para cordón con tubo liso y base entallada.
(Cordón no incluido).

Poste Con y sin bola

tubo: Ø 50mm

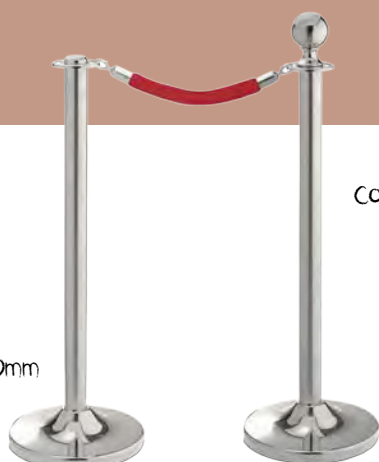

10.908

10.910

Cordón no incluido

Referencia	Color	Tamaño	
10.908		Ø320x910mm	x2
10.910		Ø320x1000mm	

Poste Con y sin bola

tubo: Ø 50mm

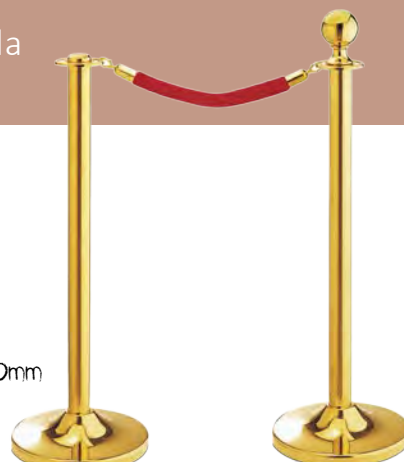

10.909

10.911

Referencia	Color	Tamaño	
10.909		Ø320x910mm	x2
10.911		Ø320x1000mm	

Poste con marco



10.914



10.915



10.912



10.913

Referencia	Color	Tamaño	
10.914		Ø320x1300mm	x2
10.915		Ø320x1300mm	

Referencia	Color	Tamaño	
10.912		Ø320x1440mm	x2
10.913		Ø320x1440mm	

Accesorios para Postes

Accesorios para Postes

Cordones



Cordones trenzados

Referencia	Cordón	Endcap	Longitud
10.923			1500mm
10.924			1500mm
10.925			1500mm

Cordones lisos

Referencia	Cordón	Extremo	Longitud
10.919			1500mm
10.920			1500mm
10.921			1500mm
10.922			1500mm

Barra Cromada 1200mm para Poste Separador

Anillo Cromada Ø 100mm para Poste Separador

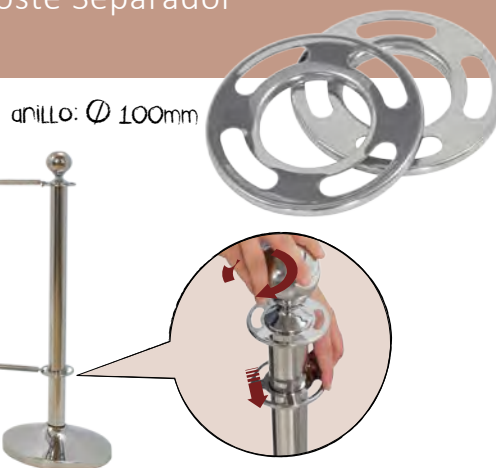

Referencia	Color	Longitud	Tubo	
10.990		1200mm	Ø 20mm	11.85 €/Uni.

Referencia	Color	Diámetro	
10.991		Ø 100mm	2.95 €/Uni.

ideal para terrazas de bar, bancos, hoteles.



ejemplo con gráfica

Postes Exterior 

Poste Delimitador para Exterior

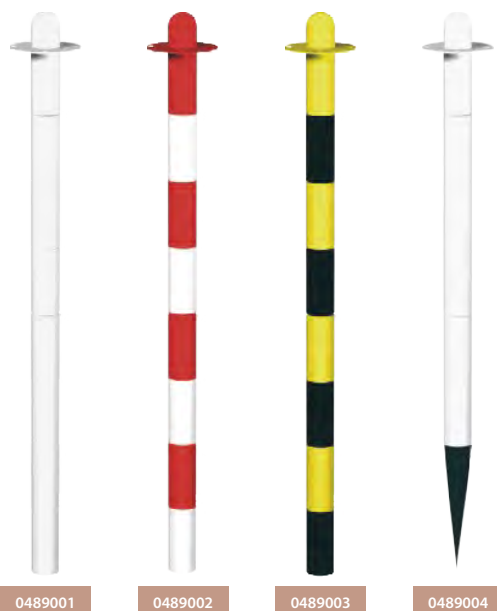

Referencia	Color	Tamaño
0489001		Ø40x900mm
0489002		Ø40x900mm
0489003		Ø40x900mm
0489004		Ø40x800mm

Base para Postes



Referencia	Tamaño
0489005	Square - 300x300mm
0489006	Round - Ø 300mm

Bolardo Flexible Reflectante

NEW



Referencia	Altura
80.302	800mm

Poste Portátil

NEW

alta visibilidad
banda reflectante

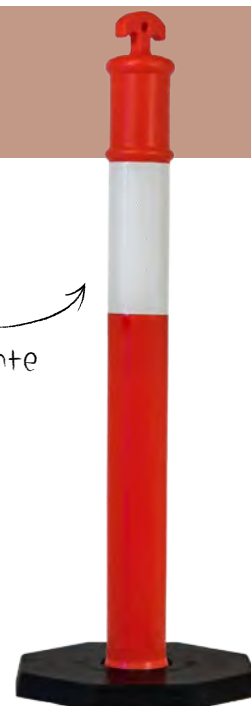

Referencia	Altura
80.301	1100mm

Conos 

Conos



0489017



0489018



0489019

Referencia	Color	Altura	
0489017		300mm	
0489018		300mm	x20
0489019		300mm	



0489020



0489021



0489022



0489023

Referencia	Color	Altura	
0489020		500mm	
0489021		500mm	x10
0489022		500mm	
0489023		500mm	

Cono Reflectante con base de caucho

NEW

rubber base



80.513

80.512

80.511

Referencia	Color	Altura	Base
80.513		500mm	280mm
80.512		750mm	380mm
80.511		1000mm	490mm

Cono Plegable con bandas reflectantes

NEW



80.501

80.502

80.503

Referencia	Color	Altura	Base
80.501		400mm	243mm
80.502		500mm	243mm
80.503		700mm	340mm

Cono Precaución

NEW



80.603

80.604

Referencia	Tamaño
80.603	280x280x670mm
80.604	280x280x670mm

Señal Plegable

NEW



80.601

80.602

Referencia	Tamaño
80.601	250x300x620mm
80.602	250x300x620mm

Cadena de Plástico



Referencia	Color	Ancho	Longitud
0489011		5mm	25m
0489012		5mm	25m
0489008		8mm	25m
0489009		8mm	25m
0489010		8mm	25m

Cinta Señalización



Referencia	Color	Ancho	Longitud	
0479001		80mm	200m	x5
0479004		80mm	200m	

Conector para cadenas



Referencia	Ancho	
0489015	5mm	x25
0489014	8mm	

Tapón para cono



Referencia	Colores	
0489024		x10

Topo Cono con cinta retráctil

NEW



para conos de más de 3kg de peso

Referencia	Longitud de cinta
80.516	3m

Luz Intermitente para Cono

NEW



pilas no incluidas

Referencia	Diámetro
80.504	Ø 8mm



Paleta de Stop

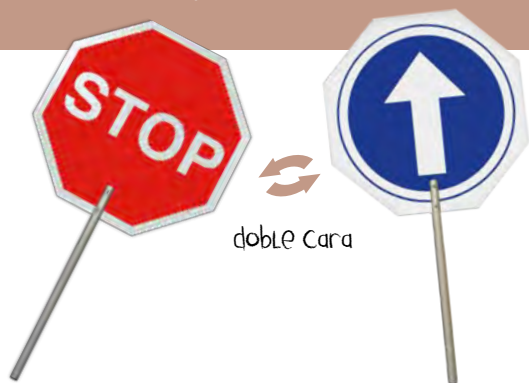

Referencia	Tamaño	
0080011	590x300mm	x3

Batuta Luminosa



Referencia	Tamaño
80.704	Ø 40x540mm

Lámpara Intermitente



Referencia	Color	LED
80.701		14 LEDs
80.702		8 LEDs

Rectángulo Reflectante para colgar



Referencia	Tamaño
0489016	140x105mm

Panel Reflectante para señalar cargas



Referencia	Tamaño
00530001	500x500mm

Soporte Espejo



Referencia	Diametro
80.104	Ø 70mm
80.124	Ø 60/40mm



Convexo Exterior

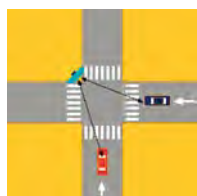

Referencia	Diámetro	Tamaño
80.101	Ø 800mm	850x860x140mm
80.121	Ø 600mm	620x630x110mm

Convexo Tráfico

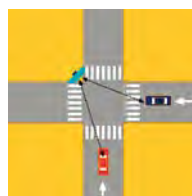

Referencia	Diámetro	Tamaño
80.103	Ø 800mm	900x900x120mm
80.123	Ø 600mm	670x670x120mm

Convexo Interior

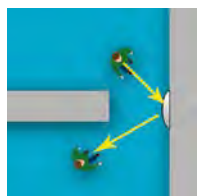

Referencia	Diámetro	Tamaño
80.102	Ø 800mm	850x850x130mm
80.122	Ø 600mm	630x630x90mm
80.131	Ø 450mm	480x480x80mm
80.141	Ø 300mm	340x340x60mm

360° Hemisférico

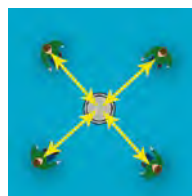

Referencia	Diámetro	Tamaño
80.111	Ø 650mm	730x730x400mm
80.132	Ø 450mm	540x540x320mm

180° Semi Hemisférico

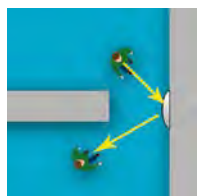

Referencia	Diámetro	Tamaño
80.112	Ø 650mm	730x420x380mm
80.133	Ø 450mm	540x350x300mm

90° Esquina

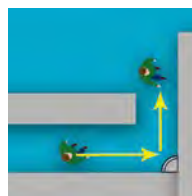

Referencia	Diámetro	Tamaño
80.113	Ø 650mm	400x400x400mm
80.134	Ø 450mm	300x300x320mm



Barrera Protectora de espacio en Parking

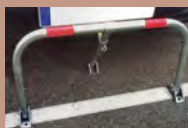

Referencia	Tamaño
0080010	400x720mm

Poste Parking protector



Referencia	Tamaño	Tubo
80.401	610x175x100mm	Ø 60mm

Tope para Rueda



Referencia	Tamaño
80.421	500x160x100mm

Tope Largo para Rueda



Referencia	Tamaño
80.427	2000x150x100mm

Protector de Muro



Referencia	Tamaño
80.426	1000x160x50mm

Taco y Tornillo metálico



Referencia	Longitud
80.611	50mm
80.613	70mm
80.614	90mm

Parking | Accesorios Parking

Equipamiento Parking



Protector Columna

fabricado en Caucho

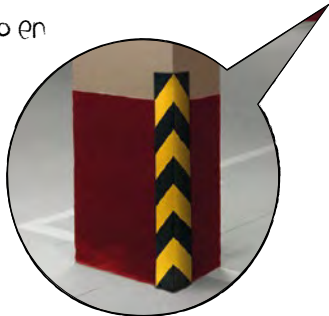

Referencia	Tamaño
80.411	800x100x10mm

Protector Redondeado

fabricado en Caucho



Referencia	Tamaño
80.412	800x120x20mm

Rampa para Bordillo



Caucho resistente

Referencia	Tamaño
80.424	600x250x100mm

Extremo Redondeado

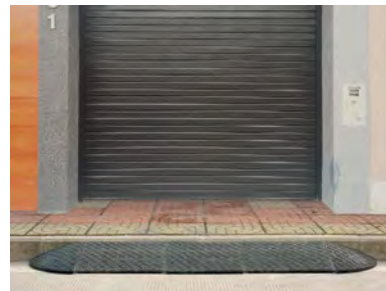

Referencia	Tamaño
80.425	250x250x100mm

Protector de Suelo para Cables

soporta hasta 40 Toneladas

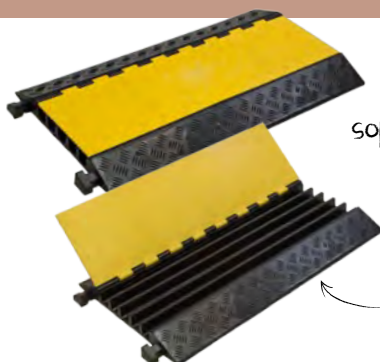

soporta hasta 10 toneladas



5 Canales para cables de hasta 42mm

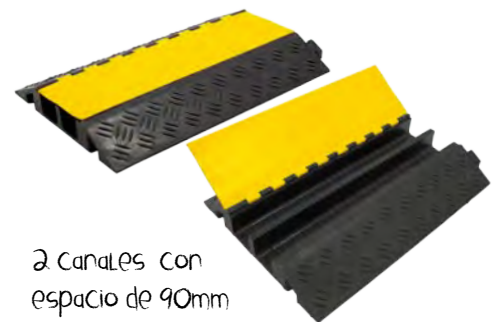

2 Canales con espacio de 90mm

Referencia	Tamaño
80.422	900x500x55mm

Referencia	Tamaño
80.423	310x500x55mm

Referencia	Tamaño
80.428	900x615x105mm

Badenes



Protector Suelo Cables

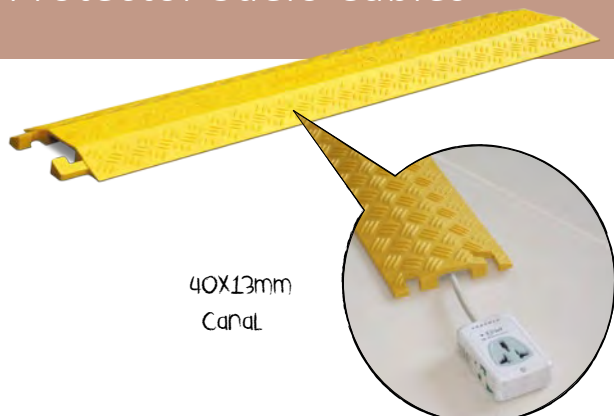

40x13mm
Canal

Referencia	Tamaño	Canal
80.429	1000x133x20mm	40x13mm

Badén Portátil

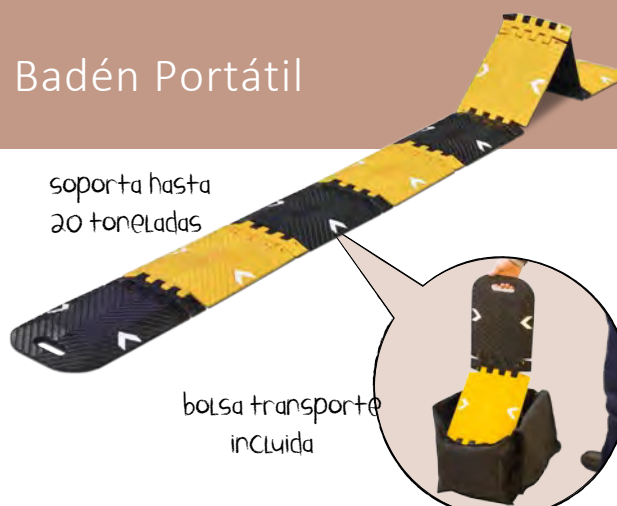

soporta hasta
20 toneladas

bolsa transporte
incluida

Referencia	Tamaño
80.417	3000x250x25mm

Badén Reductor 35mm



Referencia	Tamaño
80.413N	500x250x35mm

Referencia	Tamaño
80.413A	500x250x35mm

Referencia	Tamaño
80.414	250x250x35mm

Badén Reductor 50mm

Caucho resistente



with Cat's-eye
reflectors



Referencia	Tamaño
80.415	500x350x50mm

Referencia	Tamaño
80.416	250x350x50mm



Badén Reductor de Velocidad 30mm

fabricado en caucho resistente

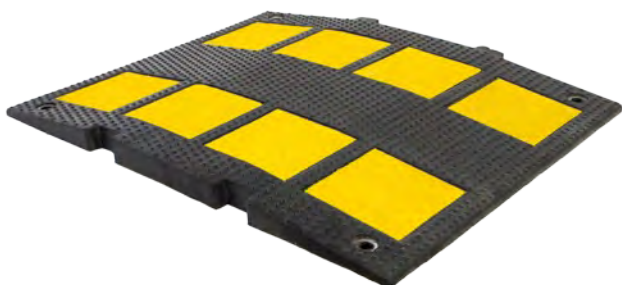

Referencia	Tamaño
80.418	500x600x30mm

Referencia	Tamaño
80.419	225x600x30mm

Badén Reductor de Velocidad 50mm

fabricado en caucho resistente



Referencia	Tamaño
80.431	500x600x50mm

Referencia	Tamaño
80.432	225x600x50mm



ideal para centros comerciales, áreas residenciales, hospitales, aeropuertos, etc.



LETREROS

“Louvre”



EN

Signage system for indoor use. Composed by two glasses of 3mm thickness each and an aluminum profile. Recommended materials: photo paper, vinyl cutting, etc. Supplied in complete kits. Fixing screws not included.

FR

Système de signalisation intérieur composé d'un "profil d'aluminium et 2 verres avec 3mm d'épaisseur chacune. Vendus en jeux complets. Matières recommandées: papier photographique, vinyle de coupe, etc. Kit complet. Vis non incluses.

PT

Sistema de sinalização para interior que inclui um perfil de alumínio e dois vidros de 3 mm de espessura. Materiais recomendados: Papel fotográfico, vinil de recorte, etc..O kit é fornecido completo.Parafusos de fixação à parede não incluídos.

ES

Sistema de señalización para uso interior. Compuesto por dos cristales de 3mm de espesor cada uno y un perfil de aluminio. Materiales recomendados: papel fotográfico, vinilo de corte, etc. Se suministra en kits completos. Tornillería de fijación no incluida.

Sistema “Louvre”

2 cristales de 3 mm de grosor incluidos

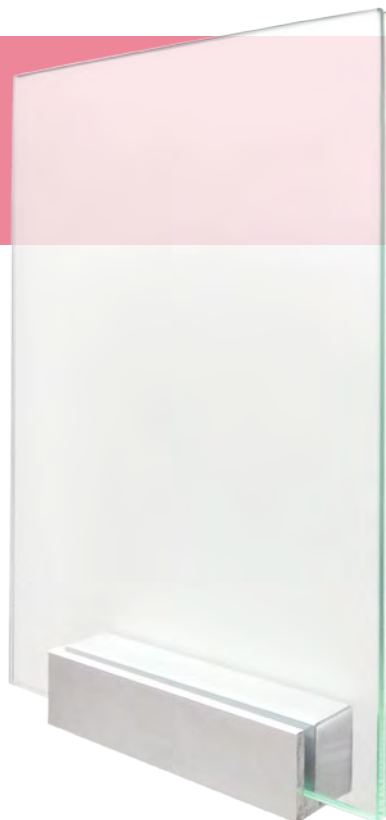

Contenido:

- Perfil de Aluminio (1 or 2)
- Dos cristales de 3 mm
- Tapas Laterales
- Llave de montaje

Referencia	Tamaño	Forma
15.571	105x105mm	
15.572	105x149mm	
15.573	149x105mm	
15.574	149x149mm	
15.575	149x210mm	
15.576	210x149mm	

Referencia	Tamaño	Forma
15.577	297x105mm	
15.578	297x149mm	
15.579	297x210mm	
15.580	420x149mm	
15.581	594x149mm	
15.582	840x149mm	
15.583	840x210mm	

“Louvre”



Instrucciones de Instalación

EN

1. Screw the aluminum fixing support to the wall.
2. Insert the glass into the aluminum profile and screw.
3. Secure the profile to the support with the bottom screw.
4. Place the plastic endcaps at both ends.

FR

1. Fixer le profil derrière au mur avec les vis.
2. Introduire les plaques en verre dans la rainure de la 2ème pièce en aluminium.
3. Fixer les deux pièces ensemble avec les vis inférieure.
4. Placer les bouchons en plastique aux extrémités.

PT

1. Aparafusar a parte traseira do perfil à parede.
2. Colocar os vidros no perfil frontal e fixá-los com o parafuso de segurança.
3. Fixar os perfis através de um parafuso colocado na parte inferior.
4. Colocar as tampas de plástico nas extremidades.

ES

1. Atornillar el soporte de fijación de aluminio a la pared.
2. Introducir el cristal en el perfil de aluminio y atornillar.
3. Fijar el perfil al soporte mediante el tornillo inferior.
4. Colocar las tapas de plástico en ambos extremos.

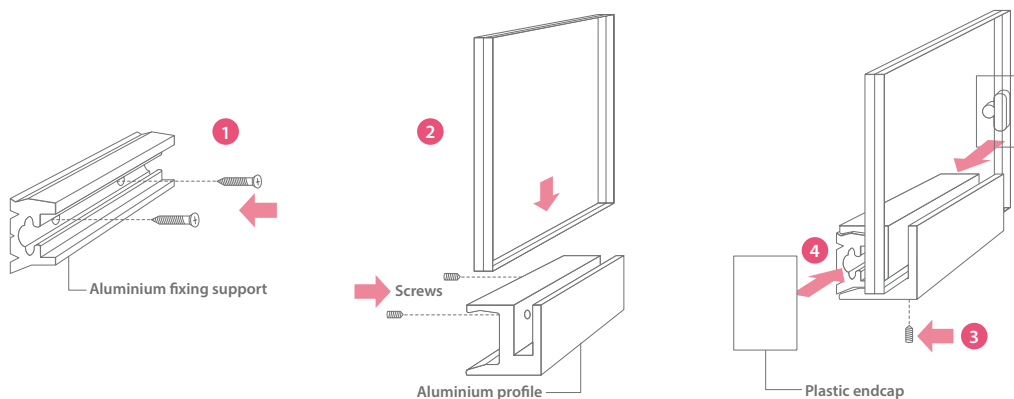

"Bargello"



EN

Standard signage system for indoor use. Composed by aluminium profiles STRAIGHT (BARGELLO) or CURVED (ORSAY) and aluminium plate. Recommended materials: digital printing and vinyl cutting. Supplied in complete kits. Graphic and screws not included.

FR

Système de signalisation composé d'un profil en aluminium droit (BARGELLO) ou courbé (ORSAY) et d'une plaque en aluminium. Matières recommandées: papier photographique, vinyle de coupe, etc. Vendus en jeux complets. Visuel et vis non incluses.

PT

Sinalização de interior com perfil recto (Bargello) ou curvo (Orsay) e placa de alumínio. Materiais recomendados: Papel fotográfico, vinil de recorte, etc. O kit é fornecido completo. Impressão e parafusos de fixação à parede não incluídos.

ES

Sistema de señalización estandar para uso interior. Compuesto por perfilera de aluminio RECTA (BARGELLO) o CURVA (ORSAY) y placa de aluminio. Materiales recomendados: impresión digital y vinilo de corte. Se suministra en kits completos. Gráfica y tornillería no incluidas.

Sistema "Bargello"

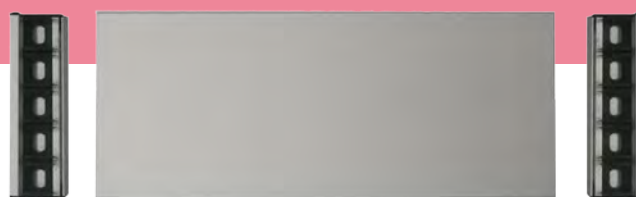

dos perfiles

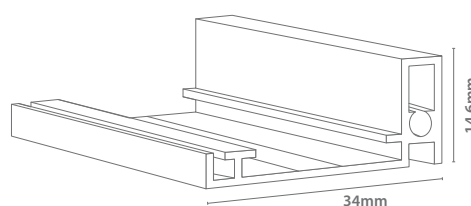

Contenido:

- Perfil recto o curvo
- Plásticos de fijación
- Placa de Aluminio
- Tapas laterales

Referencia	Tamaño
15.634	120x60mm
15.635	220x60mm
15.636	300x60mm
15.637	150x90mm
15.638	220x90mm
15.639	300x90mm
15.668	124x120mm
15.640	150x124mm
15.641	220x124mm
15.642	300x124mm

Referencia	Tamaño
15.670	150x150mm
15.643	220x150mm
15.644	300x150mm
15.645	400x150mm
15.672	180x180mm
15.646	500x60mm
15.647	500x90mm
15.648	500x124mm
15.649	500x150mm
15.650	500x180mm



Sistema "Orsay"

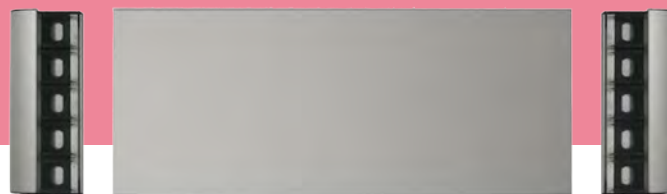
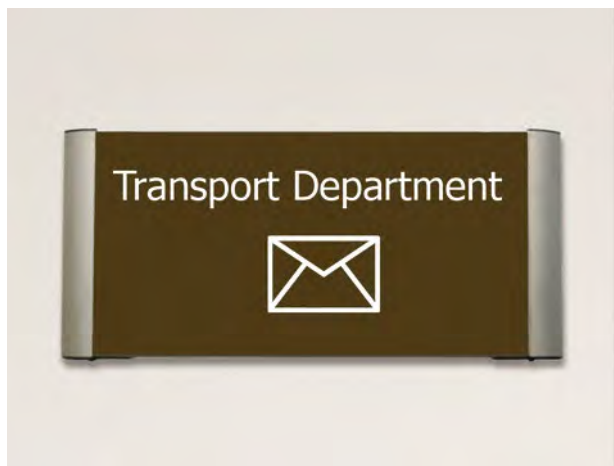

2 perfiles

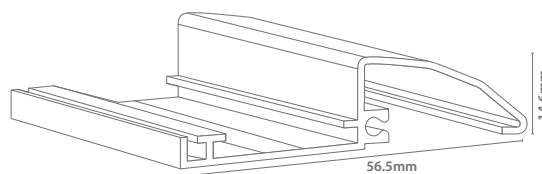

Referencia	Tamaño	
15.651	120x60mm	2.85 €
15.652	220x60mm	4.45 €
15.653	300x60mm	5.70 €
15.654	150x90mm	4.95 €
15.655	220x90mm	6.60 €
15.656	300x90mm	8.50 €
15.657	150x124mm	7.50 €
15.658	220x124mm	10.00 €
15.659	300x124mm	12.45 €

Referencia	Tamaño	
15.660	220x150mm	10.65 €
15.661	300x150mm	13.80 €
15.662	400x150mm	17.75 €
15.663	500x60mm	8.70 €
15.664	500x90mm	13.00 €
15.665	500x124mm	19.60 €
15.666	500x150mm	21.70 €
15.667	500x180mm	26.00 €

Instrucciones Instalación

EN Possibility of fixing with double sided tape. Continue with the next steps if you wish to screw it to the wall:
 1. Make two holes in the side profiles, as shown.
 2. Screw the profiles to the wall, adjusting the width of the plate.
 3. Fix the central plate by pressing on the side covers.

FR L'application peut être réalisée avec adhésif double face. Si le souhaité c'est le visser au mur, il faut suivre le spas suivants:
 1. Perforer le profil comme indiqué à l'image.
 2. Viser le profil au mur, en respectant la taille de la plaque.
 3. Faire pression sur la plaque pour la fixer au profil.

PT Pode colocar o sistema na parede utilizando fita dupla face. Siga os passos seguintes se o pretendido é aparafusá-lo:
 1. Perforar o perfil conforme o indicado.
 2. Aparafusar o perfil à parede, respeitando o tamanho da placa.
 3. Coloque a placa pressionado nos laterais, junto ao perfil.

ES Posibilidad de fijar con cinta de doble cara. Continue con los siguientes pasos si desea atornillar a pared:
 1. Hacer dos perforados en los perfiles laterales, según se indica.
 2. Atornillar las tapas a la pared, ajustando al ancho de la placa.
 3. Fijar la placa central presionando sobre las tapas laterales.

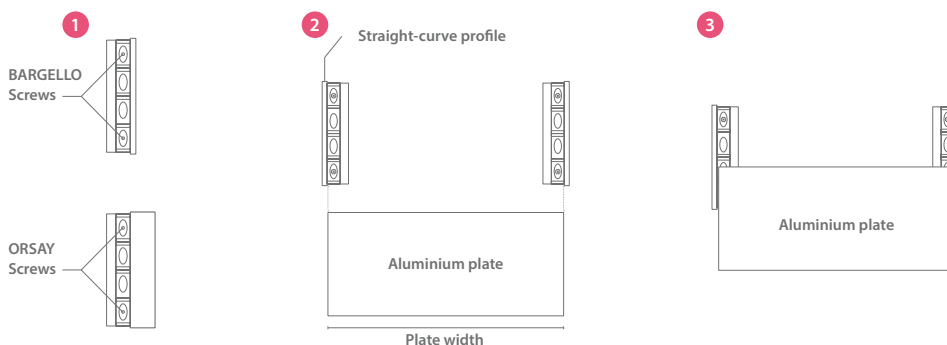

“Special”



EN Standard curved sign system. Composed by curved aluminium profiles and aluminium plate. Recommended materials: digital printing and vinyl cutting. Supplied in complete kits. Graphic and screws not included.

FR Système de signalisation courbé composé d'un profil et des plaques en aluminium. Matières recommandées: impression digitale et vinyle de coupe, etc. Vendus en jeux complets. Visuel et vis non incluses.

PT Sistema de sinalização curvo que inclui um perfil e uma placa de alumínio. Materiais recomendados: impressão digital e vinil de recorte. O kit é fornecido completo. Impressão e parafusos de fixação à parede não incluídos.

ES Sistema de señalización curvo estandar. Compuesto de perfilera de aluminio curvo y placas de aluminio. Materiales recomendados: impresión digital y vinilo de corte. Se suministra en kits completos. Gráfica y tornillería no incluidas.

Sistema “Special”



Incluye plástico protector

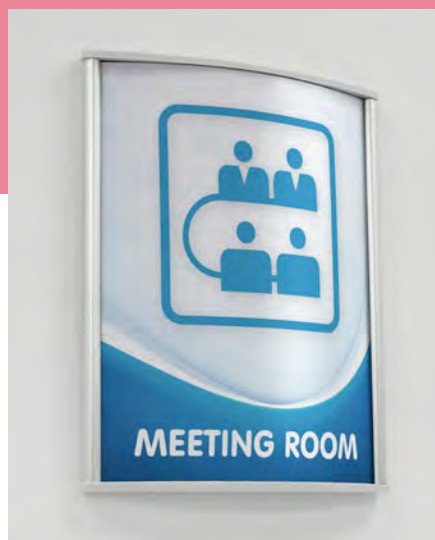

Contenido:

- Perfil de aluminio curvo
- Plástico frontal
- Plástico transparente

Referencia	Tamaño
15.614	200x200mm
15.615	200x250mm
15.616	200x300mm
15.617	300x400mm
15.618	500x500mm

Instrucciones Instalación

EN 1. Remove the two front plastic panels.
2. Make two holes and screw to the wall, as indicated.
3. Reattach the front panels inserting between them the graphic you want, pressing on the side covers.

FR 1. Retirer les panneaux frontaux en plastiques.
2. Percer le mur e vissé le profil, comme à l'image.
3. Remettre les panneaux, et parmi eux le visuel, en faisant pression sur les coins.

PT 1. Retirar os dois plásticos frontais.
2. Realizar os furos na parede e aparafusar o perfil como indicado.
3. Recoloque os painéis, introduzindo no meio a impressão desejada, e pressionado nas esquinas junto ao perfil.

ES 1. Retirar los dos paneles frontales de plástico.
2. Hacer dos perforados y atornillar a la pared, según se indica.
3. Fijar de nuevo los paneles frontales intercalando entre ellos la gráfica que desee, presionando sobre las tapas laterales.

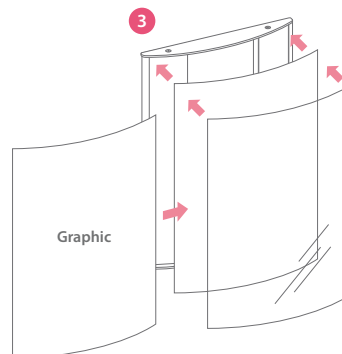
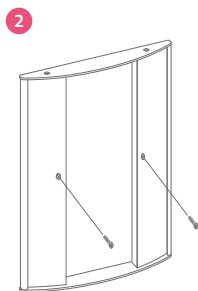
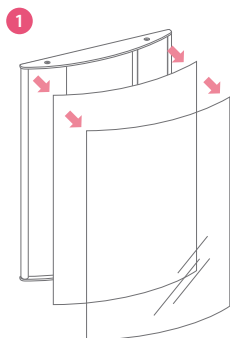



EN

Signaling system composed by curved aluminum plates and side covers. Available in 3 different widths. This system allows the composition of curved wall directories according to customer needs. The components of this system are supplied separately.

FR

Système de signalisation avec profil d'aluminium courbé et bouchons latéraux. Disponible en 3 hauteurs différentes. Ce système permet la création de panneaux directionnels en fonction des besoins de clients. Les éléments de ce système sont vendus séparément.

PT

Perfil curvo de alumínio com tampas laterais para a criação de placas de sinalização. Está disponível em 3 alturas diferentes. Este sistema permite a construção de placas de sinalização mediante as necessidades do cliente. Os componentes deste sistema são vendidos por separado.

ES

Sistema de señalización compuesto por placas de aluminio curvas y tapas laterales. Disponible en 3 anchos distintos. Este sistema permite la composición de directorios de pared curvos según la necesidad del cliente. Los componentes de este sistema se suministran por separado.

Sistema Directorio Curvo

Incluye plástico protector

Referencia	Altura
10.224	60mm
10.225	90mm
10.226	140mm

Referencia	
10.233	Corte Perfil

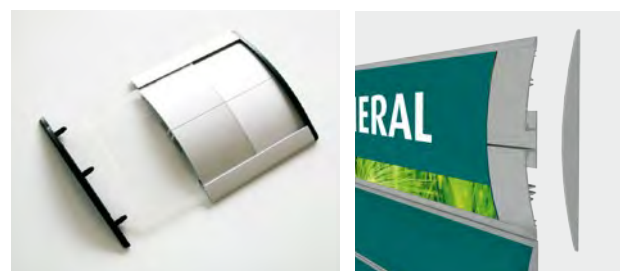
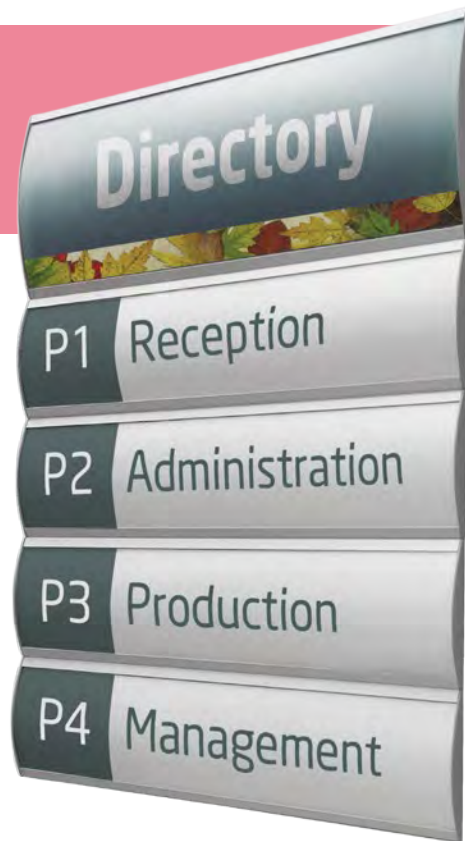

Referencia	Color	Altura	
10.227	■	60mm	x10
10.230	■	60mm	x10

Referencia	Color	Altura	
10.228	■	90mm	x10
10.231	■	90mm	x10

Referencia	Color	Altura	
10.229	■	140mm	x10
10.232	■	140mm	x10

Letreros

Data Frame

EN Signaling system with plastic frame that allows you to change the graphics easily. Available in different sizes.



FR Système de signalisation en plastique qui permet le changement de visuel facilement. Disponible en plusieurs dimensions.

PT Sistema de sinalização em plástico que permite a troca de imagem facilmente. Disponível em vários tamanhos.

ES Sistema de señalización con marco de plástico que permite cambiar la gráfica fácilmente. Disponible en varios tamaños diferentes.

Data Frame



Referencia	Color	Tamaño
15.200		149x63mm
15.201		149x104mm
15.202		149x145mm

Instrucciones Instalación

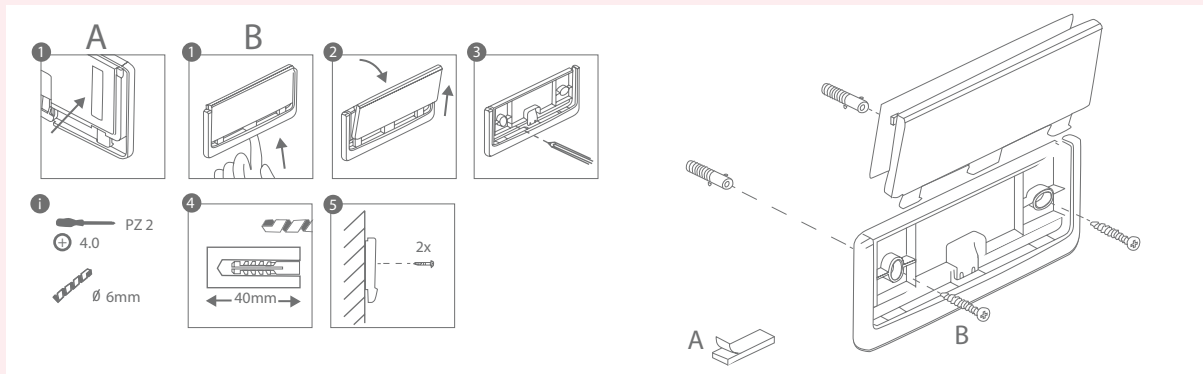

Marco Acrílico Adhesivo

adhesivos incluidos

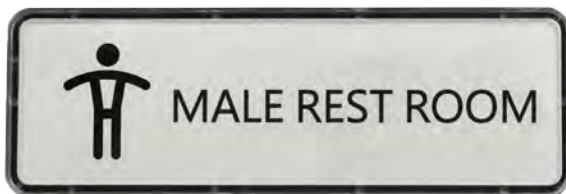

Referencia	Tamaño
15.207	195x60mm

Referencia	Tamaño
15.208	66x66mm



EN Double-sided flag sign system for fixing on the wall. Recommended materials: digital printing and vinyl cutting. Supplied in complete kits. Graphic and screws not included.

FR Système composé de plaques d'aluminium double face à fixer au mur. Matières recommandées: vinyle de coupe et impression digitale. On les fournit en jeux complets. Graphique et vis non inclus.

PT Sistema composto de placas de alumínio de dupla face para fixar à parede. Materiais recomendados: vinil de corte e impressão digital. Fornece-se em kits completos. Impressão e parafusos não incluídos.

ES Sistema de señalización de banderola a doble cara para fijar a pared. Materiales recomendados: impresión digital y vinilo de corte. Se suministra en kits completos. Gráfica y tornillería no incluidas.

Banderola Doble Cara



Contenido:

- Placas de aluminio doble cara
- Soporte de fijación
- Tapas laterales

Referencia	Tamaño
15.685	220x90mm
15.686	320x90mm
15.687	220x124mm
15.688	320x124mm
15.689	420x124mm

Referencia	Tamaño
15.690	150x150mm
15.691	220x150mm
15.692	320x150mm
15.693	420x150mm

Instrucciones Instalación

EN 1. Remove the plastic endcaps and the aluminium plate.
2. Screw the aluminium support to the wall, as indicated.
3. Reattach the aluminium plate and the plastic endcaps.

FR 1. Retirer les bouchons de plastique et la plaque d'aluminium.
2. Percer le support d'aluminium au mur, comme à l'image.
3. Remettre les bouchons de plastique et la plaque d'aluminium.

PT 1. Retirar as tampas de plástico e a placa de alumínio.
2. Aparafusar o suporte de alumínio à parede, como indicado.
3. Recolocar a placa de alumínio e as tampas de plástico.

ES 1. Retirar las tapas de plástico y la placa de aluminio.
2. Atornillar el soporte de aluminio a la pared, según se indica.
3. Fijar de nuevo el panel de aluminio y las tapas de plástico.

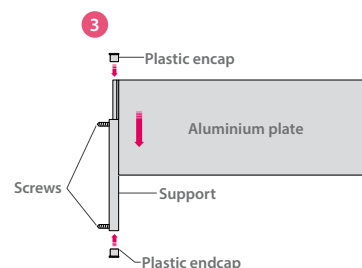
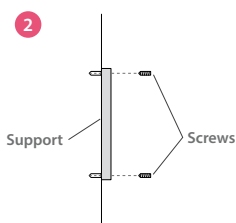
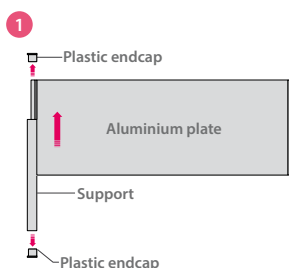

Banderola Curva Doble Cara

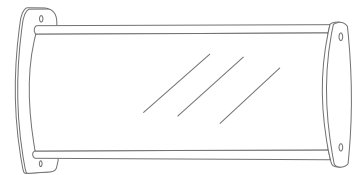
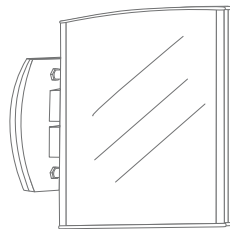
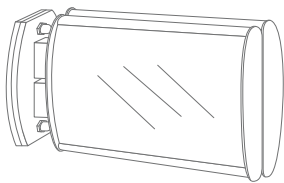

Referencia	Tamaño	Precio
15.619	150x115mm	16.00 €
15.620	180x115mm	17.55 €
15.621	220x115mm	20.25 €
15.625	150x150mm	24.50 €
15.626	180x150mm	27.70 €

Referencia	Tamaño	Precio
15.622	115x150mm	16.00 €
15.623	115x180mm	17.55 €
15.624	115x220mm	20.25 €
15.627	150x180mm	27.70 €
15.628	150x200mm	30.60 €

Referencia	Tamaño	Precio
15.629	220x115mm	15.80 €
15.630	280x115mm	19.75 €
15.631	300x115mm	21.15 €
15.632	150x150mm	20.10 €
15.633	250x150mm	31.70 €

Instrucciones Instalación con Separador

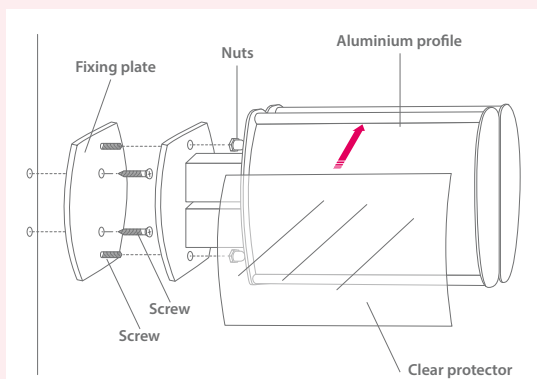

Instrucciones Instalación Directa a Muro

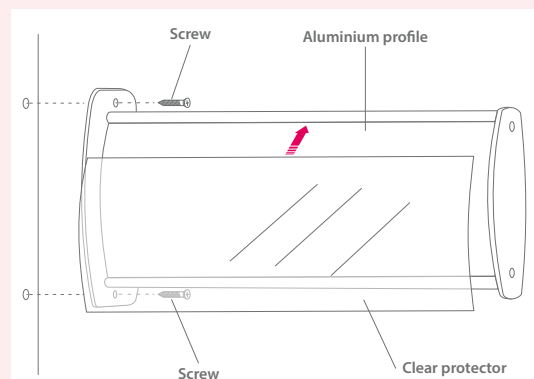



Acrílico Aluminio

2 Láminas acrílicas de 3mm de grosor incluidas

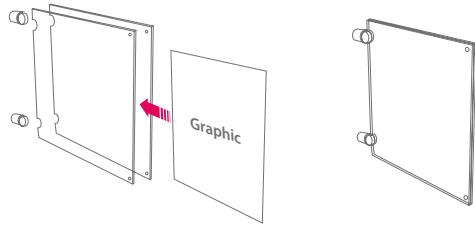

Referencia	Color	Tamaño
15.203		297x120mm
15.204		120x297mm
15.205		210x297mm
15.206		210x210mm



EN LED light sign system. Supplied in complete kits. Clear panel and screws not included.

FR Système de signalisation avec lumière (LED). Vendus en jeux complets. Plaque transparente et vis non incluses.

PT Sistema de sinalização com LEDs. Fornece-se em kits completos. Painel transparente e parafusos não incluídos.

ES Sistema de señalización con luz LED. Se suministra en kits completos. Panel transparente y tornillería no incluidos.

Luz LED



Luz LED



Cristal o acrílico no incluidos

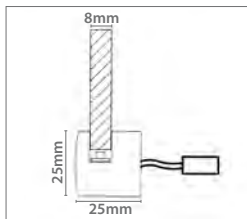

- Content:**
- Satin aluminium profile
 - White LEDs inside
 - Power supply
 - Plug and wires

Cristal o acrílico no incluidos

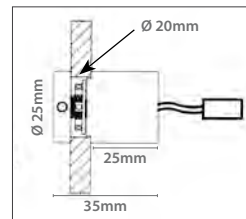

- Content:**
- Stand-offs with 6 LED bulbs
 - Power supply
 - Plug and wires

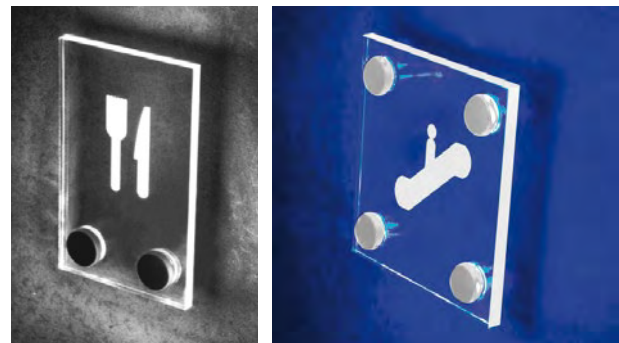

Referencia	Tamaño	LED
15.725	120mm	9 LEDs
15.726	180mm	12 LEDs
15.727	280mm	21 LEDs

Referencia	Tamaño	
15.724	25x25mm	x4



EN Sign system for tabletops that allows to change the graphic information easily. Available in different sizes.

FR Système de signalisation pour les comptoirs qui permet le changement de visuel facilement. Disponible en plusieurs dimensions.

PT Sistema de sinalização de mesa que permite a mudança de informação facilmente. Disponível em vários tamanhos.

ES Sistemas de señalización para encimeras que permite cambiar la gráfica fácilmente. Disponible en varios tamaños.

Placa de Aluminio



Referencia	Tamaño
15.599	180x115mm
15.600	200x115mm
15.601	250x115mm
15.602	350x115mm
15.603	300x150mm

Instrucciones Instalación

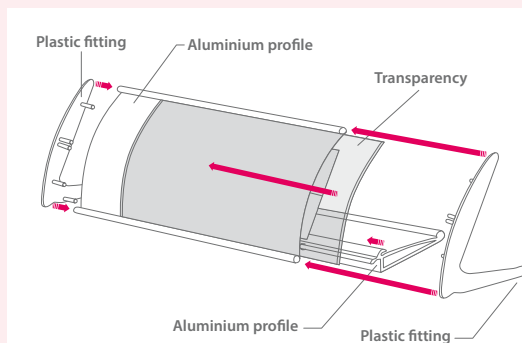

Placa de Acero



Referencia	Color	Tamaño	
15.567		80x Ø8mm	x2



Referencia	Color	Tamaño	
15.568		80x Ø8mm	x2



Referencia	Color	Tamaño	
15.569		80x Ø8mm	x2



Referencia	Color	Tamaño	
15.570		80x Ø8mm	x2





Sistemas de Separación



Separación para Letreros

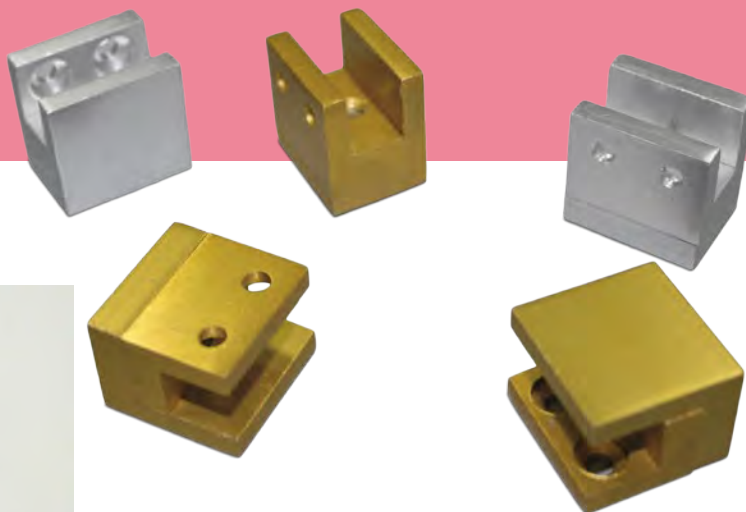

Sistema Cuadrado



Referencia	Color	Tamaño		
15.564		25x25mm	x4 	3.15 €/Uni.

Referencia	Color	Tamaño		
15.565		25x25mm	x4 	2.85 €/Uni.

Sistema Redondo

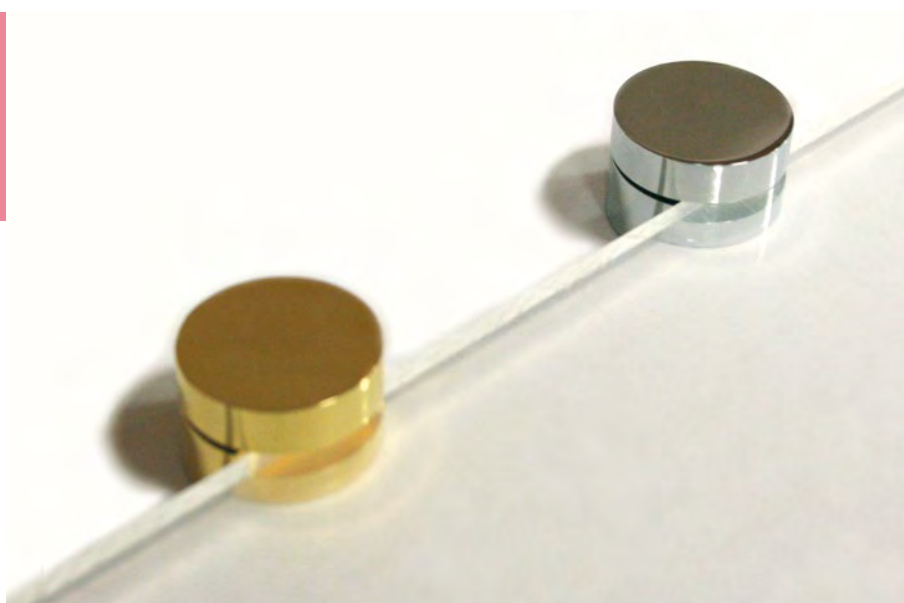

Referencia	Color	Tamaño		
15.550		Ø25x20mm	x4 	3.15 €/Uni.
15.551		Ø30x20mm	x4 	4.70 €/Uni.

Referencia	Color	Tamaño		
15.552		Ø25x20mm	x4 	3.55 €/Uni.
15.553		Ø30x20mm	x4 	4.90 €/Uni.

Sistemas de Separación

Anillas | Soportes



EN Wall mounting system for signage. This system allows to cover the fixing screws. Available in various finishes and colors.
FR Système de fixation au mur des affiches. Ce système permet de couvrir les vis de fixation. Diverses finitions et couleurs disponibles.

PT Sistemas de fixação à parede de cartazes e ocultação de parafusos. Disponível em diferentes acabamentos e cores.
ES Sistemas de fijación a pared de cartelería. Este sistema permite cubrir los tornillos de fijación. Disponible en varios acabados y colores.

Anilla Embellecedora

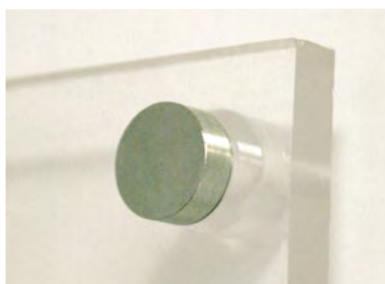

Referencia	Color	Tamaño	
15.544		Ø15mm	x4
15.545		Ø19mm	x4
15.546		Ø25mm	x4

Referencia	Color	Tamaño	
15.547		Ø15mm	x4
15.548		Ø19mm	x4
15.549		Ø25mm	x4

Soporte Aluminio



Referencia	Color	Tamaño	
15.528		Ø13x13mm	x4
15.532			
15.536			
15.540			

Referencia	Color	Tamaño	
15.530		Ø19x25mm	x4
15.534			
15.538			
15.542			

Referencia	Color	Tamaño	
15.529		Ø13x19mm	x4
15.533			
15.537			
15.541			

Referencia	Color	Tamaño	
15.531		Ø25x30mm	x4
15.535			
15.539			
15.543			



Soporte Acero para Paneles

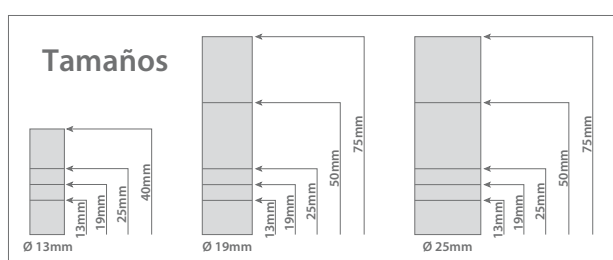

Referencia	Color	Tamaño	
15.500		Ø13x13mm	x4
15.501		Ø13x19mm	x4
15.502		Ø13x25mm	x4
15.503		Ø13x40mm	x4

Referencia	Color	Tamaño	
15.504		Ø13x13mm	x4
15.505		Ø13x19mm	x4
15.506		Ø13x25mm	x4
15.507		Ø13x40mm	x4

Referencia	Color	Tamaño	
15.508		Ø19x13mm	x4
15.509		Ø19x19mm	x4
15.510		Ø19x25mm	x4
15.511		Ø19x50mm	x4
15.512		Ø19x75mm	x4

Referencia	Color	Tamaño	
15.513		Ø19x13mm	x4
15.514		Ø19x19mm	x4
15.515		Ø19x25mm	x4
15.516		Ø19x50mm	x4
15.517		Ø19x75mm	x4

Referencia	Color	Tamaño	
15.518		Ø25x13mm	x4
15.519		Ø25x19mm	x4
15.520		Ø25x25mm	x4
15.521		Ø25x50mm	x4
15.522		Ø25x75mm	x4

Referencia	Color	Tamaño	
15.523		Ø25x13mm	x4
15.524		Ø25x19mm	x4
15.525		Ø25x25mm	x4
15.526		Ø25x50mm	x4
15.527		Ø25x75mm	x4

Sistemas de Separación

Sujeción



EN Fixing system for shelves or posters to the wall. Available in gold and chrome colors.
FR Système de fixation d'étagères ou signalisation au mur. Disponible en chromé doré ou chromé argenté.

PT Sistema de suporte para estantes ou cartazes à parede. Disponível em dourado ou prateado com acabamento cromado.
ES Sistema de fijación de estantes o cartelería a pared. Disponibles en dorado y cromado.

Sistema Sujeción Estantería o Cartelería

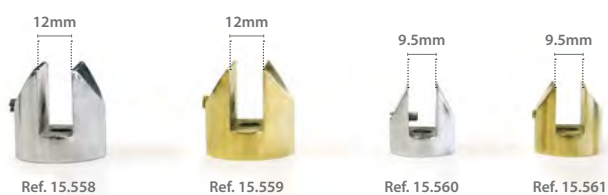

Referencia	Color	Tamaño	Max. grosor	
15.558		35x35mm	12mm	x4
15.560		25x25mm	9.5mm	x4
Referencia	Color	Tamaño	Max. grosor	
15.559		35x35mm	12mm	x4
15.561		25x25mm	9.5mm	x4

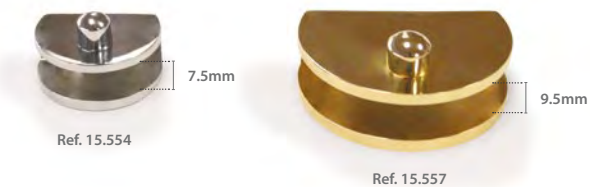

Referencia	Color	Tamaño	Max. grosor	
15.554		30mm	7.5mm	x2
15.555		50mm	9.5mm	x2
Referencia	Color	Tamaño	Max. grosor	
15.556		30mm	7.5mm	x2
15.557		50mm	9.5mm	x2



Referencia	Color	Tamaño	Max. grosor	
15.562		80x28mm	12mm	x4
15.563		50x25mm	10mm	x4



Sistemas de Separación

Sistema Cube

EN Panel support for shelves or posters using a piece of steel. Available in 3 finishes and 5 colors.
FR Pièce en acier pour la fixation des étagères ou des affiches. Disponible en trois finitions et cinq couleurs différents.





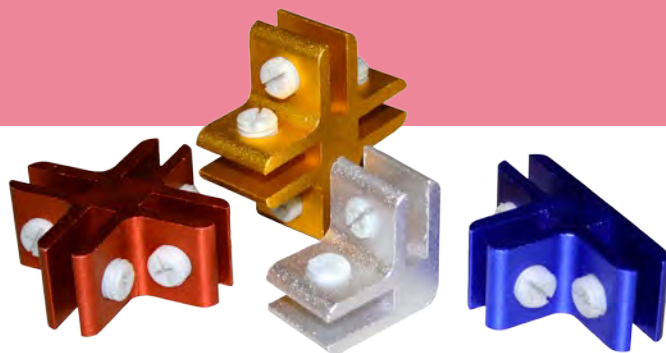
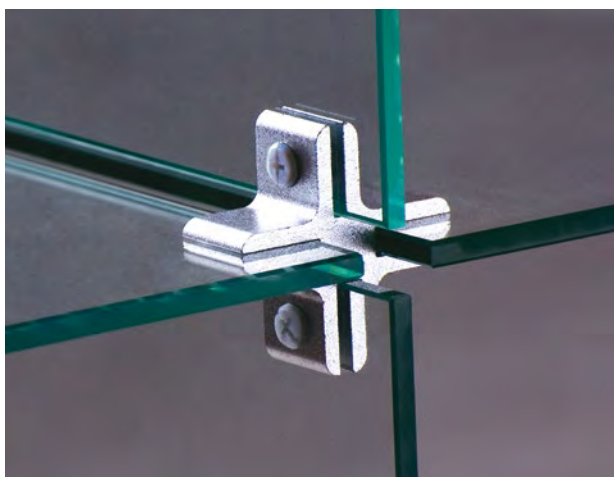



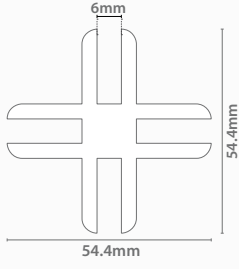

PT Sistema de fixação de estantes ou cartazes mediante uma peça de aço. Disponível em 3 acabamentos e 5 cores.
ES Sistema de sujeción de estanterías o cartelería mediante una pieza de acero. Disponibles en 3 acabados y 5 colores.

Sistema Cube



Referencia	Color		
15.182		x4 	
15.183		x4 	
15.184		x4 	
15.185		x4 	
15.186		x4 	

Referencia	Color		
15.187		x4 	
15.188		x4 	
15.189		x4 	
15.190		x4 	
15.191		x4 	

Referencia	Color		
15.192		x4 	
15.193		x4 	
15.194		x4 	
15.195		x4 	
15.196		x4 	

Sistema Outdoor

Sistema Outdoor



EN Outdoor signage system in two standard measures, composed by two aluminum poles for ground mounting and double sided aluminium profiles for better viewing.

FR Système de signalisation extérieur en 2 dimensions standard. Composé de 2 poteaux en aluminium à fixer au sol et des profils en aluminium double face pour une meilleure visualisation.

PT Sistema de sinalização exterior em duas medidas standar, composto por dois postes de alumínio para fixação ao solo e perfis de alumínio com dupla face para uma melhor visualização.

ES Sistema de señalización exterior en dos medidas estándar, compuesto de dos postes de aluminio para fijación al suelo y perfiles de aluminio a doble cara para una mejor visualización.

Sistema Outdoor

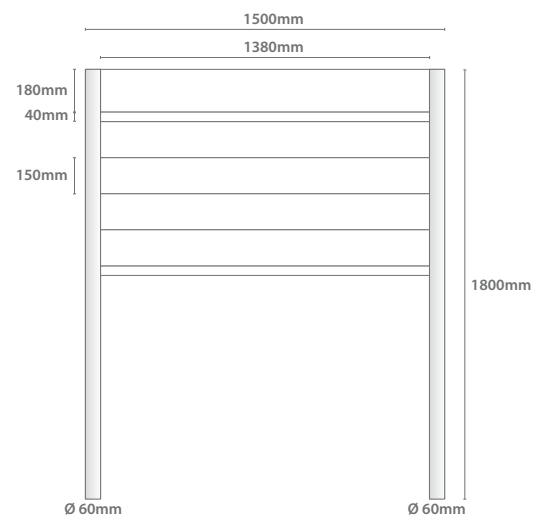
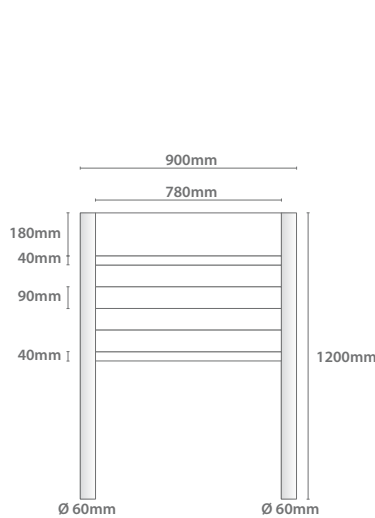

Contenido:

- 2 postes aluminio (Ø60x1200mm)
- 2 tapas negras para poste
- 1 perfil de aluminio 180mm
- 2 perfiles de aluminio 40mm
- 4 perfiles de aluminio 90mm

Contenido:

- 2 postes aluminio (Ø60x1800mm)
- 2 tapas negras para poste
- 1 perfil de aluminio 180mm
- 2 perfiles de aluminio 40mm
- 4 perfiles de aluminio 90mm

Referencia	Tamaño
15.716	900x1200mm

Referencia	Tamaño
15.717	1500x1800mm





ACCESORIOS

Accesorios

EN Squeegees for the application of vinyl.

FR Raclette pour l'application de vinyles.

PT Espátulas para aplicação de vinil.

ES Rasquetas para la aplicación de vinilos.

Squeegees

made of
100% wool



Wool	Size		
16.012	100x70x13mm	x10	
16.013	100x70x13mm	x10	

Wool	Size		
16.014	100x70x13mm	x10	
16.015	100x70x13mm	x10	



NEW



Plastic-Felt	Size		
16.096	100x70mm	x10	

Plastic	Size		
16.003	100x70mm	x10	
16.004	130x70mm	x10	



Plastic	Size		
16.000	108x240mm	x10	

Plastic	Size		
16.001	60x135mm	x10	



Plastic	Size		
16.002	90x115mm	x10	

Plastic	Size		
16.006	20x150mm	x10	

Accesorios

Accesorios

XL Squeegee

NEW



XL Squeegee	Size		
16.098	170x113mm	x10	

XXL Squeegee

NEW



XXL Squeegee	Size		
16.101	270x173mm	x5	

Plastic-Rubber Squeegee

NEW

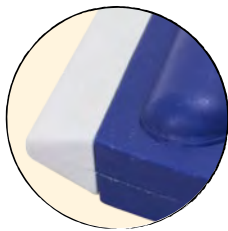

Plastic-Rubber	Size		
16.097	123x82x30mm	x10	

Wood-Rubber Squeegee

NEW



Wood-Rubber	Size		
16.099	200x110x44mm	x5	

Application Roller



Roller	Size		
16.009	165x115x30mm		

Rivet Brush



Brush	Size		
16.011	Ø40x140mm		

Accesorios

Accesorios

Cutter Metálico



D/W/M/U/S		
16.063	x5	

Cutter Profesional



D/W/M/U/S		
16.064	x5	

Economic Cutter

NEW



Economic Cutter	Size	
	130x13x10mm	x20

Mini Small Cutter



NEW

Mini Small Cutter	Size	
	75x44x3mm	x20

Snappy Safe Cutter

adjustable blade
with safety lock
system



Snappy Cutter		
	x10	

Telescopic Cutter

NEW



telescopic

with safety lock
system

Telescopic Cutter	Size	
	1700x23mm	

Accesorios

Accesorios

Tapiz de Corte

ideal! #
~' #% + " + # ~ \$flz

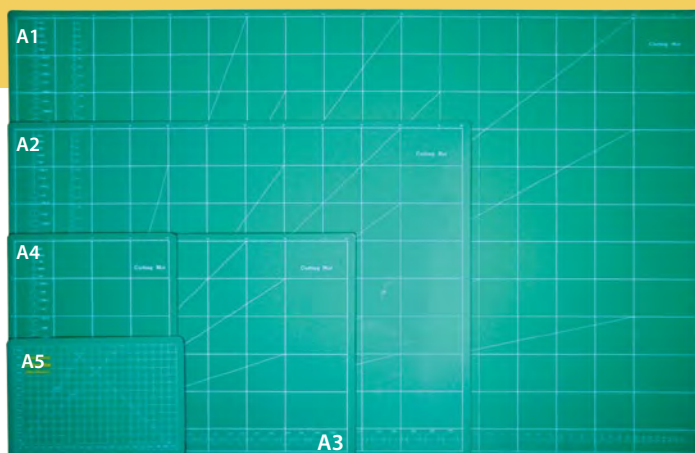

D\W\H\U\S	FS_ Sña	
16.061	A5	
16.062	A4	
16.066	A3	

D\W\H\U\S	FS_ Sña	
16.067	A2	
16.068	A1	

Tool Bag L

NEW



Size L	Size	
	280x175 mm	

Tool Bag XL

NEW



Size XL	Size	
	295x260mm	

Tool Bag XXL

NEW



Size XXL	Size	
	525x258mm	

Paleta de Plástico



Referencia			
16.008		x10	

Anillo Magnético



Referencia	Tamaño	
16.124	Ø 30mm	

Base Magnética con Mango



Referencia	Tamaño	
16.125	Ø 60 mm	

Speed Clip Small

NEW



Speed Clip Small	Diameter		
	Ø 83mm	x20	

Speed Clip Big

NEW



Speed Clip Big	Diameter		
	Ø 110mm	x20	

Herramientas

Herramientas 

Heat Gun

ideal for bending and welding plastic, softening adhesive, etc



Voltage & Frequency:	230V ~ 50Hz
Rate power I/II:	1000/2000W
Temperature I/II:	350/550° C
Air Flow I/II:	300/500 l/min.
VDE plug:	2m cable

Heat Gun	
16.128	



Voltage & Frequency:	230V ~ 50Hz
Rate power I/II:	2000W (Max)
Temperature I/II/III:	80/80-600/80-600° C
Air Flow I/II/III:	350/350/500 l/min.
VDE plug:	2m cable
Adjustable temperature	

Heat Gun	
16.129	



Voltage & Frequency:	230V ~ 50Hz
Rate power I/II:	2000W (Max)
Temperature I/II/III:	50/70-600/70-600° C
Air Flow I/II/III:	300/300/500 l/min.
VDE plug:	2m cable
Display:	LCD
Adjustable temperature	

Heat Gun	
16.130	



Herramientas

Herramientas

Magnetic Ruler



Magnetic Ruler	Length	
16.122	1000mm / 36"	

Magnetic Ruler	Length	
16.123	1000mm	

Tape Measures

4 sizes available



Meter	Size	
16.072	13x2000mm	x5
16.073	16x3000mm	x5

Meter	Size	
16.074	19x5000mm	x5
16.075	25x10000mm	x5



Meter	Size	
16.076	19x5000mm	

Measuring tape	Length	
16.070	30000mm	
16.071	50000mm	

Safety Cutting Ruler

3 sizes available



Metal Ruler	Length	
16.030	1000mm	

Metal Ruler	Length	
16.031	1500mm	

Metal Ruler	Length	
16.032	2500mm	

Herramientas

Herramientas

Hand Caliber



Hand

16.058

From 0 to 150mm

Digital Caliber



Digital

16.057

From 0 to 150mm

High Precision Pocket Scale



Precision Scale

16.055

Weight capacity

0.1 - 500gr



Precision Scale

16.056

Weight capacity

0.01 - 300gr



Linen Tester



Linen Tester

16.077

Size

33.3mm



Linen Tester

16.078

Size

50mm



Linen Tester Luxe

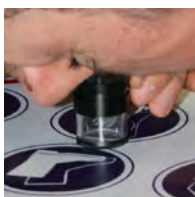

Luxe

16.079

Size

Ø 25x53mm

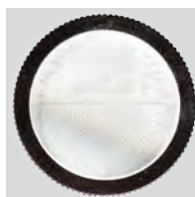
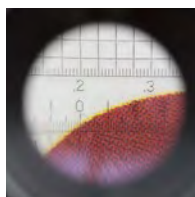

Accesorios

Accesorios

Cuerda Elástica



Referencia	Color	Diámetro	
16.039	□	Ø 6mm	
16.040	■	Ø 6mm	

Clip de Plástico



no se necesitan
herramientas

Referencia		
16.127	x20 📦	

Bobina Hilo de Nylon

Longitud: 500m



Referencia	Diámetro	Longitud	
16.037	Ø 0.4mm	500m	
16.038	Ø 0.5mm	500m	

Rollo Hilo de Nylon



Longitud: 5m

Referencia	Diámetro	Longitud	
12.373	Ø 0.5mm	5m/Uni.	x50 📦

Accesorios

Accesorios

Cable Ties



for holding graphics,
cords, cables, etc.

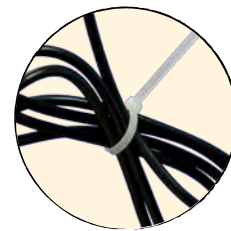

16.043
16.044

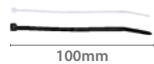

100mm

16.049
16.050



250mm

16.045
16.046



150mm

16.051
16.052



300mm

16.047
16.048



200mm

16.053
16.054



400mm

Cable Ties	Colour	Size	
16.043		2.5x100mm	x100
16.044		2.5x100mm	x100
16.045		3.6x150mm	x100
16.046		3.6x150mm	x100
16.047		4.8x200mm	x100
16.048		4.8x200mm	x100

Cable Ties	Colour	Size	
16.049		4.8x250mm	x100
16.050		4.8x250mm	x100
16.051		4.8x300mm	x100
16.052		4.8x300mm	x100
16.053		7.2x400mm	x100
16.054		7.2x400mm	x100

Ventosa para facilitar el transporte



Referencia	Capacidad
16.016	30kg

Referencia	Capacidad
16.017	60kg

Referencia	Capacidad
16.018	120kg

Accesorios

Badge Maker Machine

EN Button making machine. Includes moulds. Available in 3 different diameters 25mm, 37mm or 58mm.
 FR Machine pour réaliser des plaques avec une matrice incluse. Disponible avec matrice de dimension de 25mm, 37mm, 58mm.

PT Máquina manual para realizar crachás com matriz incluída. Os tamanhos das matrizes disponíveis são de 25 mm, 37 mm ou 58 mm.
 ES Máquina manual para realizar chapas con matriz incluida. Disponible con matrices de tamaño 25mm, 37mm ó 58mm.

Button Making Machine



available in 3 diameters



includes mold

Button Maker	Diameter	
16.131	Ø 25mm	

Button Maker	Diameter	
16.132	Ø 37mm	

Button Maker	Diameter	
16.133	Ø 58mm	

Metal Pin Badge



Metal	Diameter		
16.134	Ø 25mm	x100	
16.135	Ø 37mm	x100	
16.136	Ø 58mm	x100	

Plastic Pin Badge



Plastic	Diameter		
16.137	Ø 25mm	x100	
16.138	Ø 37mm	x100	
16.139	Ø 58mm	x100	

Accesorios

Olladora

Olladora de Mesa



adaptador 10mm incluido

Referencia	Tamaño
16.019	Ø 10mm

Adaptadores para Olladora

Referencia		Tamaño	
16.121		Ø 6mm	
Referencia		Tamaño	
16.020		Ø 8mm	
Referencia		Tamaño	
16.120		Ø 10mm	
Referencia		Tamaño	
16.021		Ø 12mm	

Olladora de Mano



100 ollados dorados incluidos



Referencia	Tamaño
16.060	Ø 4mm

Ollados

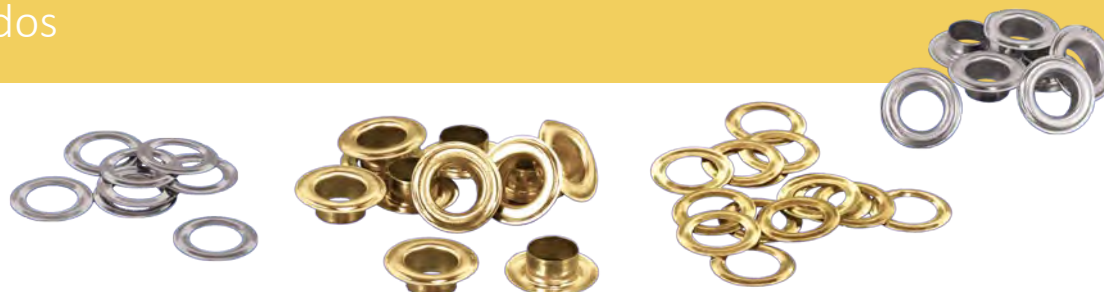

Referencia	Color	Tamaño	
16.026		Ø 6mm	x1000
16.022		Ø 6mm	x1000
16.027		Ø 8mm	x1000
16.023		Ø 8mm	x1000

Referencia	Color	Tamaño	
16.028		Ø 10mm	x1000
16.024		Ø 10mm	x1000
16.029		Ø 12mm	x1000
16.025		Ø 12mm	x1000

Accesorios

Accesorios



Discos Magnéticos

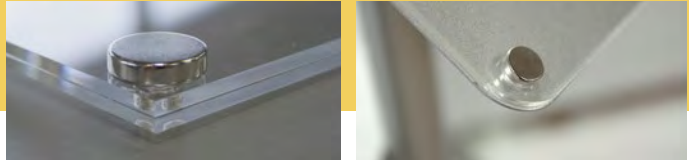

Referencia	Tamaño		
16.080	Ø 8x3mm	x10	



Referencia	Tamaño		
16.081	Ø 10x3mm	x10	

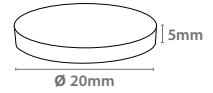

Referencia	Tamaño		
16.082	Ø 20x5mm	x10	

Base Magnética Acero Ferrita

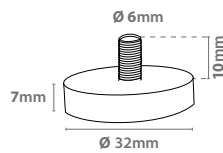

Referencia	Diameter		
16.083	Base: Ø 32x7mm Screw: Ø 6x10mm	x10	

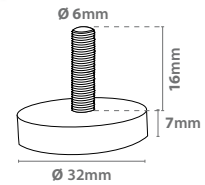

Referencia	Diameter		
16.084	Base: Ø 32x7mm Screw: Ø 6x16mm	x10	

Base Magnética Neodimio Acero

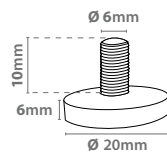

Referencia	Diameter		
16.085	Base: Ø 20x6mm Screw: Ø 6x10mm	x10	

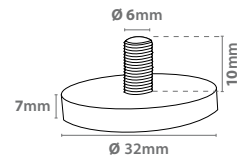

Referencia	Diameter		
16.086	Base: Ø 32x7mm Screw: Ø 6x10mm	x10	

Rollo de Imán

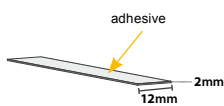

Referencia	QTY	N.W	G.W	C.B.M.	Tamaño
10.360	10	9kg	10kg	0.02	290x200x290mm
					50m x 12mm

Banda de Imán

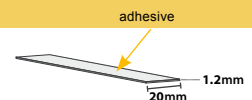

Referencia	Tamaño		
16.087	20 x 1.2mm		

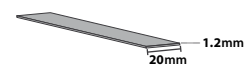

Referencia	Tamaño		
16.088	20 x 1.2mm		

Accesorios

Accesorios

Banda de Imán

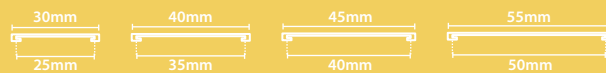

Referencia	Tamaño	
16.089	25mm	
16.090	35mm	

Referencia	Tamaño	
16.091	40mm	
16.092	50mm	

Hoja Magnética

2mm grosor



Referencia	Tamaño	
16.093	150x100x2mm	
16.094	950x400x2mm	

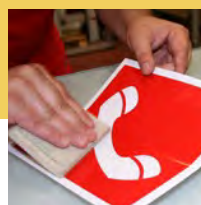

Rollo Magnético

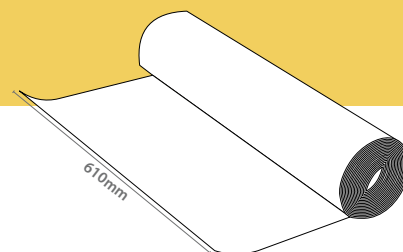

Referencia	Tamaño	
16.095	610x0.6mm x 50m	

Lágrima antideslizante

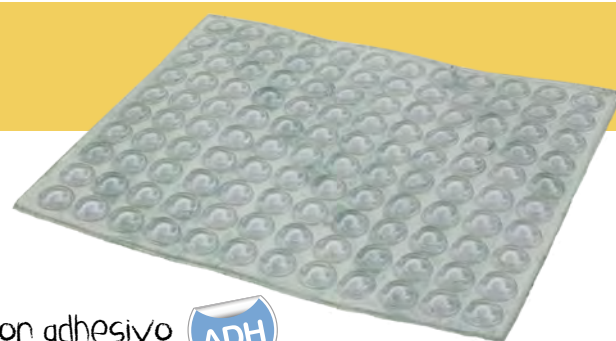

con adhesivo

Referencia	Diámetro	
16.100	Ø 10mm	x120